

Features

Regulated Converters

- 6-Side Shielding
- External ON/OFF control
- 1.6kVDC Isolation
- UL/CSA/EN-60950-1 Certified
- 2:1 Input Voltage Range
- Continuous Short Circuit Protection
- Efficiency up to 90.5%
- Fixed Switching Frequency

Description

The REC20-xxxxS_D-series offer single and dual regulated outputs in a 2"x1" package with 1.6kVDC isolation and are suitable for higher power industrial applications. Remote on/off control is standard. The higher current outputs have raised output voltages to compensate for track losses as standard. The converter is fully certified to UL/EN/IEC safety standards.

Selection Guide

Part Number	Input Voltage Range [VDC]	Output Voltage [VDC]	Output Current [mA]	Efficiency typ. [%]	max. Capacitive Load [μ F]
REC20-123.4S	9-18	3.4	5000	85	10000
REC20-125.1S	9-18	5.1	4000	89	6800
REC20-1212S	9-18	12	1670	88.5	1800
REC20-1215S	9-18	15	1340	88.5	1000
REC20-1212D	9-18	\pm 12	\pm 835	89	\pm 800
REC20-1215D	9-18	\pm 15	\pm 670	89	\pm 500
REC20-243.4S	18-36	3.4	5000	86	10000
REC20-245.1S	18-36	5.1	4000	90	6800
REC20-2412S	18-36	12	1670	89	1800
REC20-2415S	18-36	15	1340	90	1000
REC20-2412D	18-36	\pm 12	\pm 835	89.5	\pm 800
REC20-2415D	18-36	\pm 15	\pm 670	89.5	\pm 500
REC20-483.4S	36-75	3.4	5000	86.5	10000
REC20-485.1S	36-75	5.1	4000	89	6800
REC20-4812S	36-75	12	1670	89	1800
REC20-4815S	36-75	15	1340	90	1000
REC20-4812D	36-75	\pm 12	\pm 835	89.5	\pm 800
REC20-4815D	36-75	\pm 15	\pm 670	90.5	\pm 500

Model Numbering



Ordering Examples:

REC20-4812S, Single Output, 36-75Vin and 12Vout
 REC20-2412D, Dual Output, 18-36Vin and \pm 12Vout

RECOM

DC/DC Converter

REC20

20 Watt

2" x 1"

Single and Dual Output



IEC/EN60950-1 Certified
 UL60950-1 Certified
 CSA C22.2 NO. 60950 Certified
 EN55022 Certified

Specifications (measured @ $t_a = 25^\circ\text{C}$, nominal input voltage, full load and after warm up unless otherwise specified)

BASIC CHARACTERISTICS					
Parameter	Condition		Min.	Typ.	Max.
Input Voltage Range	nom. $V_{in} = 12\text{V}$ nom. $V_{in} = 24\text{V}$ nom. $V_{in} = 48\text{V}$		9VDC 18VDC 36VDC		18VDC 36VDC 75VDC
Start/up Time				10ms	
Under Voltage Lockout (UVLO)	nom. $V_{in} = 12\text{V}$	DC-DC ON DC-DC OFF		8.6VDC 7.8VDC	
	nom. $V_{in} = 24\text{V}$	DC-DC ON DC-DC OFF		17.6VDC 16.8VDC	
	nom. $V_{in} = 48\text{V}$	DC-DC ON DC-DC OFF		34.6VDC 33.8VDC	
Output Voltage Trimming	see calculation below				$\pm 10\%$
CTRL ON/OFF	DC-DC ON DC-DC OFF				Open or $3\text{V} < V_r < 12\text{V}$ Short or $0\text{V} < V_r < 1.2\text{V}$
Internal Operating Frequency				350kHz	
Minimum Load			0%		
Output Ripple and Noise ⁽¹⁾				100mVp-p	

Notes:

Note1: Ripple and Noise is measured with a 20MHz bandwidth and a 0.1µF ceramic capacitor.

Output Voltage Trimming

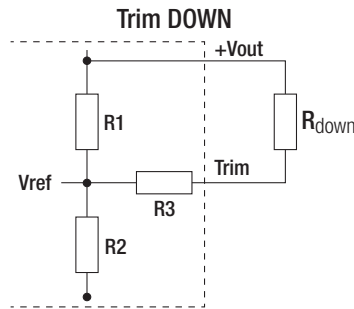
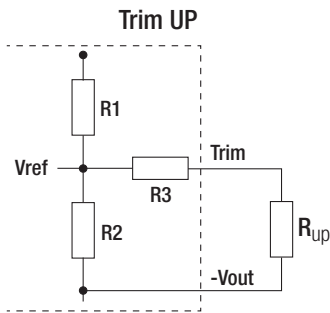

Vout	3.4V	5.1V	12V	15V
R1	2.1 kΩ	2.21 kΩ	8.87 kΩ	6.04 kΩ
R2	1.2 kΩ	2.1 kΩ	2.4 kΩ	1.2 kΩ
R3	4.7 kΩ	7.32 kΩ	15.0 kΩ	9.76 kΩ
Vref	1.24 V			

Trim Calculation

V_{out} = nom. output voltage

ΔV_{out} = output voltage trim

R_{up} = trim up resistor

R_{down} = trim down resistor

a = trim up factor

b = trim down factor

$$\Delta V_{out} = V_{out} - V_{out_{trimmed}}$$

$$R_{up} = \left[\frac{a \cdot R2}{R2 - a} \right] - R3 = \text{k}\Omega$$

$$R_{down} = \left[\frac{b \cdot R1}{R1 - b} \right] - R3 = \text{k}\Omega$$

$$a = \left[\frac{V_{ref}}{(V_{out} + \Delta V_{out}) - V_{ref}} \right] \cdot R1 = \text{k}\Omega$$

$$b = \left[\frac{(V_{out} + \Delta V_{out}) - V_{ref}}{V_{ref}} \right] \cdot R2 = \text{k}\Omega$$

Trim Up:

$V_{out} = 5.1\text{V}$, $\Delta V_{out} = 0.51\text{V}$ (10%), $V_{ref} = 2.5\text{V}$

$$a = \left[\frac{2.5\text{V}}{(5.1\text{V} + 0.51\text{V}) - 2.5\text{V}} \right] \cdot 2.21\text{k}\Omega = 1.771\text{k}\Omega$$

$$R_{up} = \left[\frac{1.771\text{k}\Omega \cdot 2.1\text{k}\Omega}{2.1\text{k}\Omega - 1.771\text{k}\Omega} \right] - 7.32 = 3.977\text{k}\Omega$$

Trim down:

$V_{out} = 5.1\text{V}$, $\Delta V_{out} = -0.51\text{V}$ (-10%), $V_{ref} = 2.5\text{V}$

$$b = \left[\frac{[5.1\text{V} + (-0.51\text{V})] - 2.5\text{V}}{2.5\text{V}} \right] \cdot 2.1\text{k}\Omega = 1.756\text{k}\Omega$$

$$R_{down} = \left[\frac{1.756\text{k}\Omega \cdot 2.21\text{k}\Omega}{2.21\text{k}\Omega - 1.756\text{k}\Omega} \right] - 7.32\text{k}\Omega = 1.219\text{k}\Omega$$

continued on next page

Specifications (measured @ $t_a = 25^\circ\text{C}$, nominal input voltage, full load and after warm up unless otherwise specified)

Efficiency vs. Load

REC20-485.1S

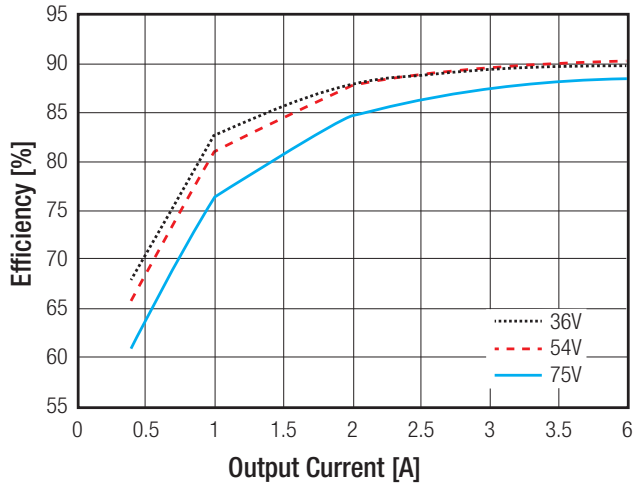

REC20-2415S

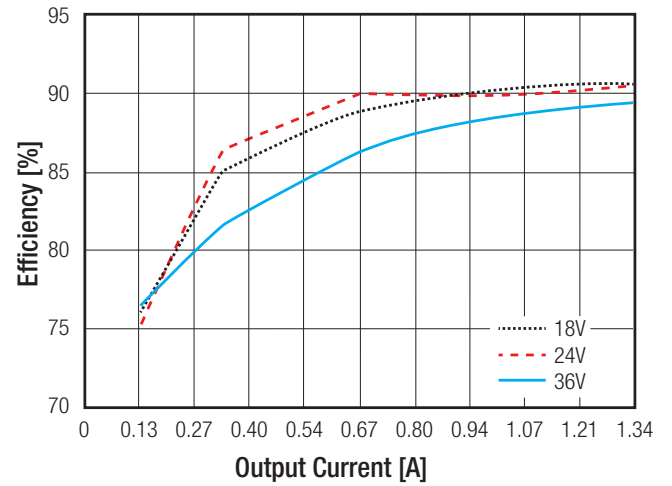

REGULATIONS

Parameter	Condition	Type	Values
Output Accuracy			$\pm 1.0\%$ typ. / $\pm 1.5\%$ max.
Line Regulation	low line to high line, full load		$\pm 0.2\%$ max.
Load Regulation	10% to 100% load		$\pm 0.5\%$ max.
Cross Regulation	25% to 100% load	dual output	$\pm 5.0\%$ max.
Transient Response Recovery Time	25% load step change		250 μs typ.

Deviation vs. Load

REC20-485.1S

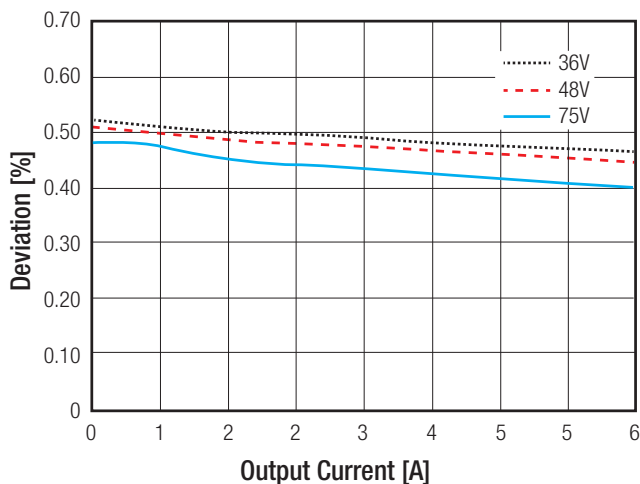

REC20-2415S

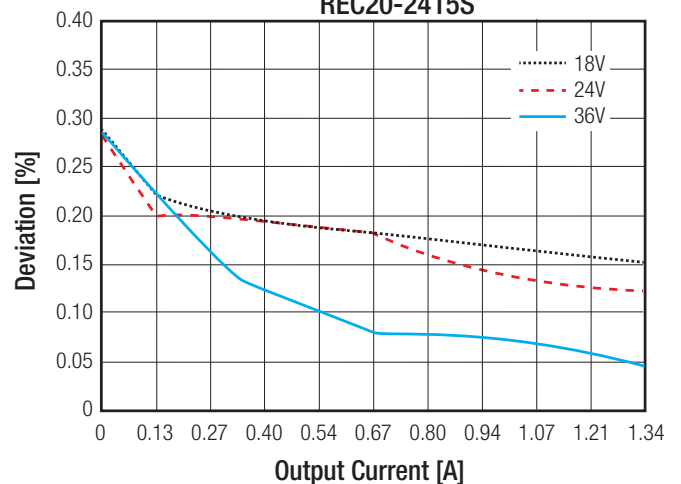

Specifications (measured @ $t_a = 25^\circ\text{C}$, nominal input voltage, full load and after warm up unless otherwise specified)

PROTECTIONS			
Parameter	Condition		Value
Short Circuit Protection (SCP)	below $100\text{m}\Omega$		continuous, automatic recovery
Over Voltage Protection (OVP)	Zener Diode Clamp	$3.4V_{out}$	3.9VDC typ.
		$5.1V_{out}$	6.2VDC typ.
		$12V_{out}$	15VDC typ.
		$15V_{out}$	18VDC typ.
Over Load Protection (OLP)			$140\% \text{ typ.}$
Isolation Voltage	I/P to O/P	tested for 1 minute	1.6kVDC
Isolation Capacitance			1000pF typ.
Isolation Resistance			$1\text{G}\Omega \text{ min.}$

ENVIRONMENTAL			
Parameter	Condition		Value
Operating Temperature Range	with derating (see graph)		$-40^\circ\text{C to } +100^\circ\text{C}$
Maximum Case Temperature			$+100^\circ\text{C}$
Temperature Coefficient			$0.05\%/^\circ\text{C typ.}$
Thermal Impedance	natural convection (0.1m/s)		12°C/W
Operating Altitude			5000m
Operating Humidity	non-condensing		$5\% - 95\% \text{ RH max.}$
Vibration			MIL-STD-202G
MTBF	according to MIL-HDBK-217F G.B., $+25^\circ\text{C}$, referring to REC20-125.1S		$607 \times 10^3 \text{ hours}$

Derating Graph

@ nominal input voltage, full load and natural convection (0.1m/s)

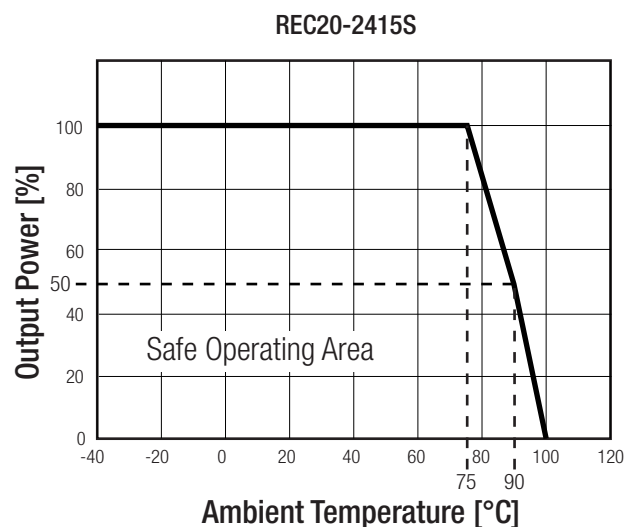
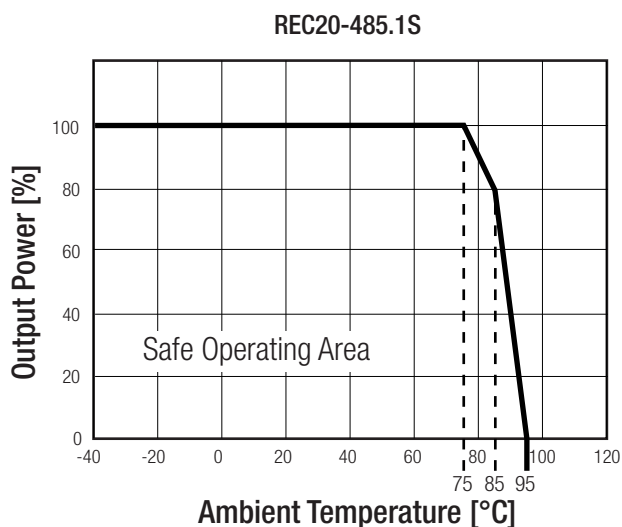

Notes:

Note2: For more details, please contact our technical support service at TechsupportAT@recom-power.com

Specifications (measured @ $t_a = 25^\circ\text{C}$, nominal input voltage, full load and after warm up unless otherwise specified)

SAFETY AND CERTIFICATIONS

Certificate Type	Report / File Number	Standard
CB General Safety	E224736	IEC60950-1, 2nd Edition, 2013
UL General Safety		UL60950-1, 2nd Edition, 2014
EN General Safety		EN60950-1, 2nd Edition, 2013
CAN/CSA General Safety		C22.2 No. 60950-1-07, 2014

EMC Compliance	Condition	Standard / Criterion
EMI	with external filter (see filter suggestions)	EN55022, Class A,B
ESD	Air: $\pm 8\text{kV}$; Contact: $\pm 4\text{kV}$	EN61000-4-2, Criteria B
Radiated Immunity	10V/m	EN61000-4-3, Criteria A
Fast Transient	$\pm 1\text{kV}$	EN61000-4-4, Criteria B
Surge ⁽³⁾	$\pm 1\text{kV}$	EN61000-4-5, Criteria A
Conducted Immunity	10Vr.m.s	EN61000-4-6, Criteria A
Power Magnetic Field	50Hz 1A/m (r.m.s)	EN61000-4-8, Criteria A

Notes:

Note3: An external MOV is required if the module has to meet EN61000-4-5. The MOV suggest: NichTek SVI32-380

EMC Filtering - Suggestions for Class A

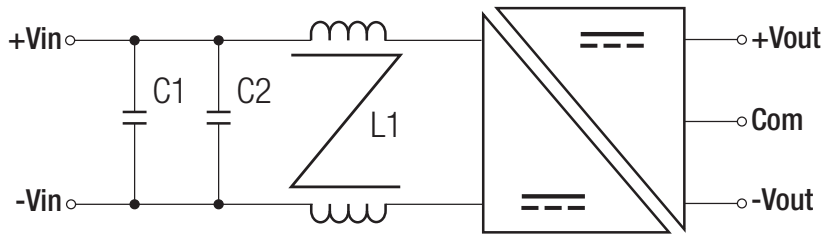

MODEL	C1	C2	L1
REC20-12xxS(D)	4.7 μF /50V	NA	0.45mH CMC
REC20-24xxS(D)	4.7 μF /50V	NA	0.45mH CMC
REC20-48xxS(D)	2.2 μF /100V	2.2 μF /100V	0.45mH CMC

EMC Filtering - Suggestions for Class B

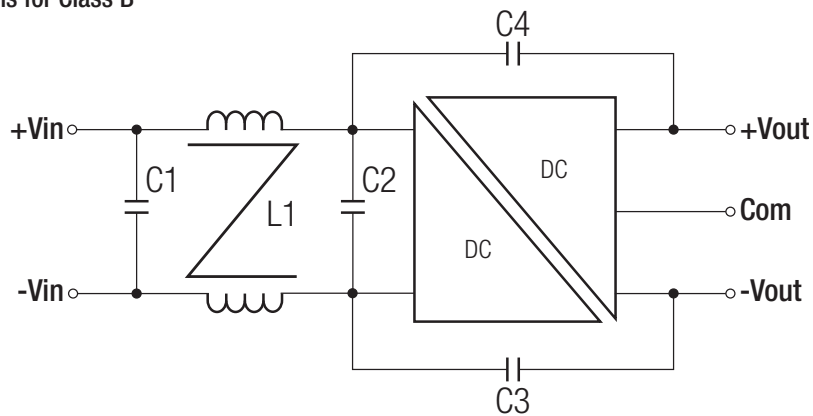

MODEL	C1	C2	L1	C3	C4
REC20-12xxS(D)	10 μF /50V	10 μF /50V	0.45mH CMC	1nF/2kV	1nF/2kV
REC20-24xxS(D)	4.7 μF /50V	NA	0.45mH CMC	1nF/2kV	1nF/2kV
REC20-48xxS(D)	2.2 μF /100V	4.7 μF /100V	0.67mH CMC	3.3nF/2kV	3.3nF/2kV

Specifications (measured @ $t_a = 25^\circ\text{C}$, nominal input voltage, full load and after warm up unless otherwise specified)

DIMENSION and PHYSICAL CHARACTERISTICS

Parameter	Type	Value
Material	Case	nickel plated copper
	Base	non conductive black plastic
	PCB	FR4
	Potting	epoxy (UL94 V-0)
Package Dimension (LxWxH)		50.8 x 25.4 x 10.2mm
Package Weight		27g typ.

Dimension Drawing (mm)

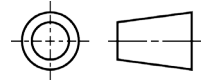
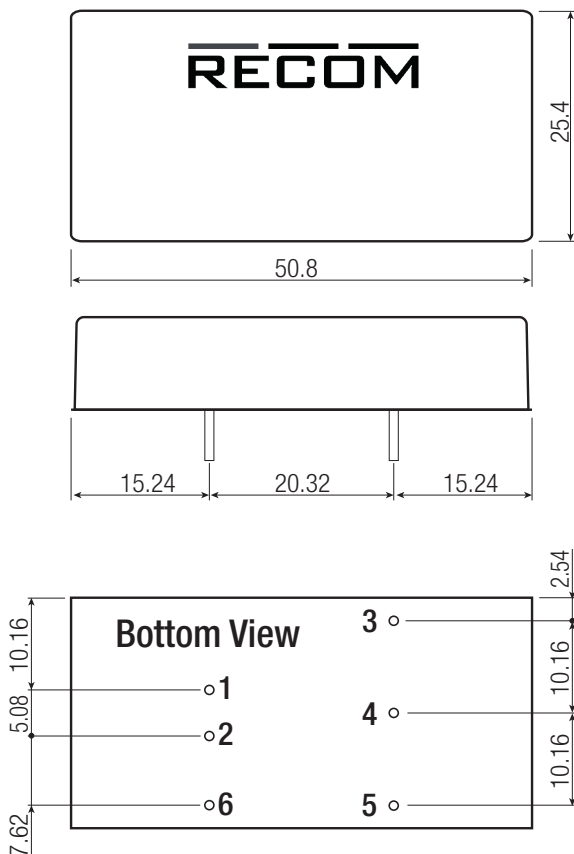

Pin Connections

Pin #	Single	Dual
1	+Vin	+Vin
2	-Vin	-Vin
3	+Vout	+Vout
4	Trim	Com
5	-Vout	-Vout
6	CTRL On/Off	

Tolerance: xx.x= ±0.5mm
 xx.xx= ±0.35mm
 Pin dimension: ±0.05mm

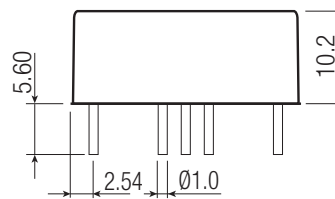

Recommended Footprint Details

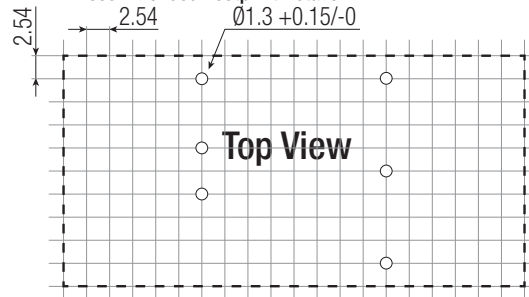

PACKAGING INFORMATION

Packaging Dimension (LxWxH)	tube	520.0 x 54.5 x 21.0mm
Packaging Quantity		18pcs
Storage Temperature Range		-55°C to +125°C