

F150-3

Vision Sensor

**Manual 1:
SETUP MANUAL**

OMRON

F150-3

Vision Sensor

Setup Manual

Revised July 2006

READ AND UNDERSTAND THIS DOCUMENT

Please read and understand this document before using the products. Please consult your OMRON representative if you have any questions or comments.

WARRANTY

OMRON's exclusive warranty is that the products are free from defects in materials and workmanship for a period of one year (or other period if specified) from date of sale by OMRON.

OMRON MAKES NO WARRANTY OR REPRESENTATION, EXPRESS OR IMPLIED, REGARDING NON-INFRINGEMENT, MERCHANTABILITY, OR FITNESS FOR PARTICULAR PURPOSE OF THE PRODUCTS. ANY BUYER OR USER ACKNOWLEDGES THAT THE BUYER OR USER ALONE HAS DETERMINED THAT THE PRODUCTS WILL SUITABLY MEET THE REQUIREMENTS OF THEIR INTENDED USE. OMRON DISCLAIMS ALL OTHER WARRANTIES, EXPRESS OR IMPLIED.

LIMITATIONS OF LIABILITY

OMRON SHALL NOT BE RESPONSIBLE FOR SPECIAL, INDIRECT, OR CONSEQUENTIAL DAMAGES, LOSS OF PROFITS OR COMMERCIAL LOSS IN ANY WAY CONNECTED WITH THE PRODUCTS, WHETHER SUCH CLAIM IS BASED ON CONTRACT, WARRANTY, NEGLIGENCE, OR STRICT LIABILITY.

In no event shall responsibility of OMRON for any act exceed the individual price of the product on which liability is asserted.

IN NO EVENT SHALL OMRON BE RESPONSIBLE FOR WARRANTY, REPAIR, OR OTHER CLAIMS REGARDING THE PRODUCTS UNLESS OMRON'S ANALYSIS CONFIRMS THAT THE PRODUCTS WERE PROPERLY HANDLED, STORED, INSTALLED, AND MAINTAINED AND NOT SUBJECT TO CONTAMINATION, ABUSE, MISUSE, OR INAPPROPRIATE MODIFICATION OR REPAIR.

SUITABILITY FOR USE

THE PRODUCTS CONTAINED IN THIS DOCUMENT ARE NOT SAFETY RATED. THEY ARE NOT DESIGNED OR RATED FOR ENSURING SAFETY OF PERSONS, AND SHOULD NOT BE RELIED UPON AS A SAFETY COMPONENT OR PROTECTIVE DEVICE FOR SUCH PURPOSES. Please refer to separate catalogs for OMRON's safety rated products.

OMRON shall not be responsible for conformity with any standards, codes, or regulations that apply to the combination of products in the customer's application or use of the product.

At the customer's request, OMRON will provide applicable third party certification documents identifying ratings and limitations of use that apply to the products. This information by itself is not sufficient for a complete determination of the suitability of the products in combination with the end product, machine, system, or other application or use.

The following are some examples of applications for which particular attention must be given. This is not intended to be an exhaustive list of all possible uses of the products, nor is it intended to imply that the uses listed may be suitable for the products:

- Outdoor use, uses involving potential chemical contamination or electrical interference, or conditions or uses not described in this document.
- Nuclear energy control systems, combustion systems, railroad systems, aviation systems, medical equipment, amusement machines, vehicles, safety equipment, and installations subject to separate industry or government regulations.
- Systems, machines, and equipment that could present a risk to life or property.

Please know and observe all prohibitions of use applicable to the products.
NEVER USE THE PRODUCTS FOR AN APPLICATION INVOLVING SERIOUS RISK TO LIFE OR PROPERTY WITHOUT ENSURING THAT THE SYSTEM AS A WHOLE HAS BEEN DESIGNED TO ADDRESS THE RISKS, AND THAT THE OMRON PRODUCT IS PROPERLY RATED AND INSTALLED FOR THE INTENDED USE WITHIN THE OVERALL EQUIPMENT OR SYSTEM.

PERFORMANCE DATA

Performance data given in this document is provided as a guide for the user in determining suitability and does not constitute a warranty. It may represent the result of OMRON's test conditions, and the users must correlate it to actual application requirements. Actual performance is subject to the OMRON Warranty and Limitations of Liability.

CHANGE IN SPECIFICATIONS

Product specifications and accessories may be changed at any time based on improvements and other reasons.

It is our practice to change model numbers when published ratings or features are changed, or when significant construction changes are made. However, some specifications of the product may be changed without any notice. When in doubt, special model numbers may be assigned to fix or establish key specifications for your application on your request. Please consult with your OMRON representative at any time to confirm actual specifications of purchased products.

DIMENSIONS AND WEIGHTS

Dimensions and weights are nominal and are not to be used for manufacturing purposes, even when tolerances are shown.

ERRORS AND OMISSIONS

The information in this document has been carefully checked and is believed to be accurate; however, no responsibility is assumed for clerical, typographical, or proofreading errors, or omissions.

PROGRAMMABLE PRODUCTS

OMRON shall not be responsible for the user's programming of a programmable product, or any consequence thereof.

COPYRIGHT AND COPY PERMISSION

This document shall not be copied for sales or promotions without permission.

This document is protected by copyright and is intended solely for use in conjunction with the product. Please notify us before copying or reproducing this document in any manner, for any other purpose. If copying or transmitting this document to another, please copy or transmit it in its entirety.

Notice:

OMRON products are manufactured for use according to proper procedures by a qualified operator and only for the purposes described in this manual.

The following conventions are used to indicate and classify precautions in this manual. Always heed the information provided with them. Failure to heed precautions can result in injury to people or damage to property.

 **Caution** Indicates a potentially hazardous situation which, if not avoided, may result in minor or moderate injury, or property damage.

	Indicates the possibility of injury by high temperature under specific conditions.
---	--

Visual Aids

The following headings will help you locate different types of information.

Note Indicates information of particular interest for efficient and convenient operation of the product.

→ Indicates pages where additional information can be found.

1. Indicates a procedure. The step numbers in the procedure correspond to the numbers in any related illustrations.

Trademark

DeviceNet is a registered trademark of the Open DeviceNet Vendor Association, Inc.

© OMRON, 2000

All rights reserved. No part of this publication may be reproduced, stored in a retrieval system, or transmitted, in any form, or by any means, mechanical, electronic, photocopying, recording, or otherwise, without the prior written permission of OMRON.

No patent liability is assumed with respect to the use of the information contained herein. Moreover, because OMRON is constantly striving to improve its high-quality products, the information contained in this manual is subject to change without notice. Every precaution has been taken in the preparation of this manual. Nevertheless, OMRON assumes no responsibility for errors or omissions. Neither is any liability assumed for damages resulting from the use of the information contained in this publication.

TABLE OF CONTENTS

PRECAUTIONS	xi
1 Safety Precautions	xii
2 General Precautions	xiii
SECTION 1	
Before Installing	1
1-1 Installation Precautions	2
1-2 Confirming Package Contents	6
1-3 Product Availability	6
SECTION 2	
Product Introduction	7
2-1 Overview of F150 Application	8
2-2 Component Names and Functions	9
2-3 Connections	12
2-4 Power Supply and Ground	14
2-5 Cameras with Light Sources	17
2-6 CCTV Lens	20
2-7 Lighting	23
2-8 Two-camera Unit	25
2-9 Mounting the Controller	27
SECTION 3	
Terminal Blocks	29
3-1 Crimp Terminals and Cables	30
3-2 Specifications	30
3-3 Terminals	31
SECTION 4	
RS-232C Connection	35
4-1 Connector	36
4-2 Wiring	37
4-3 Connection	38
SECTION 5	
CompoBus/D Connections	39
5-1 Overview	40
5-2 Communications Specifications	44
5-3 DIP Switch Settings	45
5-4 Connector Pin Allocation	47
5-5 LED Indicators	48
5-6 Multi-vendor Applications	48

TABLE OF CONTENTS

SECTION 6	
Troubleshooting	55
6-1 Connection Errors	56
6-2 Errors during Menu Operation	56
6-3 Terminal Block Errors	56
6-4 RS-232C Communications Errors	57
6-5 Two-camera Unit	57
6-6 LED Indicators (for F150-C10E-3-DRT).	58
SECTION 7	
Maintenance	59
7-1 Maintenance Parts and Replacement	60
7-2 Regular Inspections	62
SECTION 8	
Specifications	63
8-1 F150 Vision Mate Controller	64
8-2 Cameras	66
8-3 Two-camera Unit	70
8-4 Console	72
8-5 Cables	72
8-6 LCD Monitor	74
Revision History	77

About this Manual:

This manual describes the hardware for the F150 Vision Sensor and how to install the components, and it includes the sections described below. This is one of two manuals used to operate the F150. Refer to the following table for the contents of each manual.

Manual	Contents	Cat. No.
1: Setup Manual	Provides information on system hardware and installation. Be sure to read this manual first.	Z141
2: Expert Menu Operation Manual	Describes operation of the F150 using the Expert Menu. The Expert Menu enables application of all F150 capabilities, including setting region images and criteria.	Z142

Please read the above manuals carefully and be sure you understand the information provided before attempting to install or operate the F150.

Section 1 Before Installing describes the precautions that must be taken when installing and operating the F150 Vision Sensor.

Section 2 Product Introduction provides an overview of F150 application and describes the wiring, Cameras, optical lenses, lighting modes, and light guides used in the F150 System. It also describes how to mount the Vision Mate Controller to DIN Track or to a flat surface.

Section 3 Terminal Blocks describes how to connect the terminal blocks.

Section 4 RS-232C Connection describes how to connect the RS-232C port.

Section 5 CompoBus/D Connections describes how to connect the F150-C10E-3-DRT Vision Sensor as a CompoBus/D Slave and provides information such as connector pin allocations, node number settings, and baud rate settings.

Section 6 Troubleshooting lists the errors that may occur, along with their probable causes and remedies.

Section 7 Maintenance provides information on maintenance and inspection.

Section 8 Specifications provides the specifications of the F150 components.



WARNING

Failure to read and understand the information provided in this manual may result in personal injury or death, damage to the product, or product failure. Please read each section in its entirety and be sure you understand the information provided in the section and related sections before attempting any of the procedures or operations given.











PRECAUTIONS

This section provides general precautions for using the F150 Vision Sensor.

The information contained in this section is important for the safe and reliable application of the F150 Vision Sensor. You must read this section and understand the information contained before attempting to set up or operate a F150 Vision Sensor.

1	Safety Precautions	xii
2	General Precautions	xiii

1 Safety Precautions

-  **Caution** Do not touch fluorescent or halogen lights while the power is ON or immediately after the power is turned OFF. These lights generate heat and can cause burns.
-  **Caution** Do not use the F150 in environments with flammable or explosive gases.
-  **Caution** Install the F150 away from high-voltage equipment or motors to ensure safety during operation and maintenance.
-  **Caution** Use crimp terminals for wiring. Do not connect bare stranded wires directly to terminals.
-  **Caution** Cover the terminal blocks with the Terminal Block Protection Covers after wiring.
-  **Caution** Use DC power supplies with safe extra low-voltage circuits that prevent occurrences of high voltages in the main F150 power supply and power supplies for the terminal blocks.
-  **Caution** Use the power supply cables and crimp terminals of specified sizes.
-  **Caution** Use at the power supply voltages specified in this manual.
-  **Caution** Be sure to securely tighten the screws when mounting F150 components.
-  **Caution** Do not dismantle, repair or modify any F150 components.
-  **Caution** Dispose of F150 components as industrial waste.



2 General Precautions

The user must operate the product according to the performance specifications described in the setup manual.

Before using the product under conditions which are not described in the manual or applying the product to nuclear control systems, railroad systems, aviation systems, vehicles, combustion systems, medical equipment, amusement machines, safety equipment, and other systems, machines, and equipment that may have a serious influence on lives and property if used improperly, consult your OMRON representative.

Make sure that the ratings and performance characteristics of the product are sufficient for the systems, machines, and equipment, and be sure to provide the systems, machines, and equipment with double safety mechanisms.

SECTION 1

Before Installing

This section describes the precautions that must be taken when installing and operating the F150 Vision Sensor.

1-1	Installation Precautions	2
1-1-1	F150 Components	2
1-1-2	Installation Site.	2
1-1-3	Installation	2
1-1-4	Cables.	4
1-1-5	Camera	4
1-1-6	Video Monitor	5
1-1-7	Prevention of Electrostatic Discharge	5
1-1-8	Turning OFF the Power	5
1-1-9	RESET Terminal	5
1-1-10	Power ON Sequence for Two-camera Unit (F150-A20)	5
1-2	Confirming Package Contents.	6
1-3	Product Availability.	6

1-1 Installation Precautions

The F150 is highly reliable and resistant to most environmental factors. The following guidelines, however, must be followed to ensure reliability and optimum use of the F150.

1-1-1 F150 Components

Be sure to use the Camera, Camera Cable, and Console designed for the F150.

1. F150-S1A Camera
2. F150-VS Camera Cable
3. F150-KP Console

1-1-2 Installation Site

Do not install the F150 in locations subject to the following conditions:

1. Ambient temperatures outside of 0 to 40°C for the F300-M09 Video Monitor (recommended monitor) or outside of 0 to 50°C for all other F150 components
2. Condensation due to rapid temperature fluctuations
3. Relative humidities outside 35% to 85%
4. Corrosive or flammable gases
5. Dust, salt, or iron particles
6. Direct vibration or shock
7. Direct sunlight
8. Water, oil, or chemical fumes or spray

1-1-3 Installation

Orientation of Controller

To improve heat dissipation, install the Controller in the following orientation only:

CORRECT

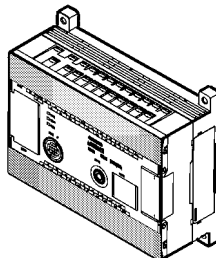

Do not install the Controller in the orientations shown in the following diagram.

INCORRECT

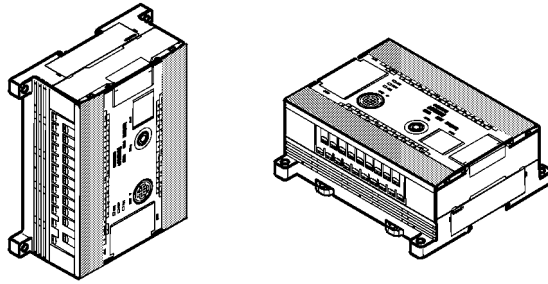

Ambient Temperature

1. Maintain a minimum clearance of 50 mm above and below F150 components to improve air circulation.
2. Do not install F150 components immediately above strong heat sources, such as heaters, transformers, or large-capacity resistors.
3. Do not let the ambient operating temperature exceed 50°C.
4. Provide a forced-air fan or air conditioning if the ambient temperature might exceed 50°C.

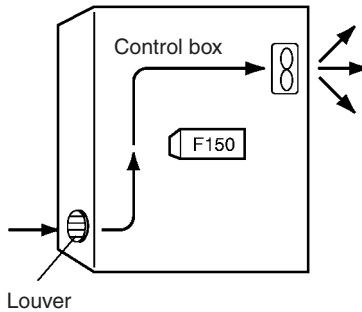

Noise Resistance

Use the following measures to help increase noise resistance.

1. Do not install F150 components in a cabinet containing high-voltage equipment.

2. Do not install the F150 components within 200 mm of power cables.

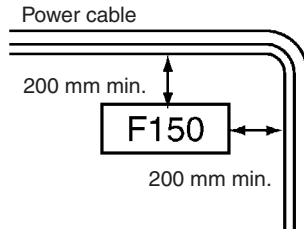

F150-C10E-3-DRT (CompoBus/D Model)

1. Since the product is defined as built-in type, install the product inside the control panel.
2. Do not apply external forces exceeding 50 N to CompoBus/D connectors. When wiring communications cables, remove the connectors from the F150.
3. Before setting the DIP switch or connecting cables, turn OFF the Programmable Controller, F150, and the communications power supply.
4. Observe the following precautions when wiring communications cables.
 - a) Separate communications cables from power lines or high-tension lines.
 - b) Do not bend communications cables.
 - c) Do not pull on communications cables with excessive force.
 - d) Do not place heavy objects on communications cables.
 - e) Be sure to route communications cables within ducts.

1-1-4 Cables

Always turn OFF the power before connecting or disconnecting cables.

1-1-5 Camera

The Camera's case is connected to the 0V line in the internal circuits. Heed the following precautions to prevent noise interference.

1. Do not ground the Camera.
2. Do not remove the base attached to the Camera.

3. Do not remove the core attached to the F150-VS Camera Cable.

1-1-6 Video Monitor

(When using the recommended F300-M09)

Heed the following precautions to prevent noise interference if the video monitor case is metallic, because it is connected to the 0V line in the internal circuits.

1. Do not ground the video monitor.
2. Do not ground the metallic part of the connector.
3. Secure the video monitor with plastic screws if it is being mounted to a metallic surface.

1-1-7 Prevention of Electrostatic Discharge

To prevent damage from static electricity, use a wrist strap or another device for preventing electrostatic discharge when touching terminals or connector signal lines.

1-1-8 Turning OFF the Power

Do not turn OFF the power while a message is being displayed indicating that processing is being performed. Data in memory will be destroyed, and the F150 may not operate correctly the next time it is started.

1-1-9 RESET Terminal

Do not use RESET input immediately after power is turned ON. When using RESET input to synchronize execution timing, wait at least 1 s after turning ON the F150 power supply before turning ON the RESET terminal.

1-1-10 Power ON Sequence for Two-camera Unit (F150-A20)

If the F150 and the Two-camera Unit need to be started sequentially, turn ON the Two-camera Unit first and then turn ON the F150. If they are turned ON in the reverse order, image data may not be read correctly.

1-2 Confirming Package Contents

Check the contents of the package as soon as you receive the F150. Contact the nearest OMRON representative if any of the following items are missing.

F150-C10E-3

F150-C15E-3

- | | | |
|----|------------------------------|---|
| 1. | F150 Vision Mate Controller | 1 |
| 2. | Setup Manual (this manual) | 1 |
| 3. | Expert Menu Operation Manual | 1 |

F150-C10E-3-DRT

- | | | |
|----|--|---|
| 1. | F150 Vision Mate Controller | 1 |
| 2. | Setup Manual (this manual) | 1 |
| 3. | Expert Menu Operation Manual | 1 |
| 4. | CompoBus/D Connector (MSTB2.5/5-STF-5.08AU by Phoenix Contact) | 1 |

1-3 Product Availability

Some of the products listed may not be available in some countries. Please contact your nearest OMRON sales office by referring to the addresses provided at the back of this manual.

SECTION 2

Product Introduction

This section provides an overview of F150 application and describes the wiring, Cameras, optical lenses, lighting modes, and light guides used in the F150. It also describes how to mount the Vision Mate Controller to DIN Track or to a flat surface.

2-1	Overview of F150 Application	8
2-2	Component Names and Functions	9
2-3	Connections.	12
2-4	Power Supply and Ground	14
2-4-1	Crimp Terminals and Cables	14
2-4-2	Protective Conductor (Earth) Wiring	15
2-4-3	Wiring the Power Supply	15
2-5	Cameras with Light Sources	17
2-6	CCTV Lens	20
2-6-1	Optical Chart	20
2-6-2	Lens	22
2-6-3	Extension Tubes	22
2-7	Lighting.	23
2-7-1	Lighting Methods.	23
2-8	Two-camera Unit.	25
2-8-1	Connecting to the Power Supply	25
2-8-2	Connecting to the F150	25
2-8-3	Connecting to Cameras	26
2-9	Mounting the Controller	27
2-9-1	Mounting to DIN Track	27
2-9-2	Mounting on a Flat Surface	28

2-1 Overview of F150 Application

The following table shows the basic steps that must be performed to use the F150.

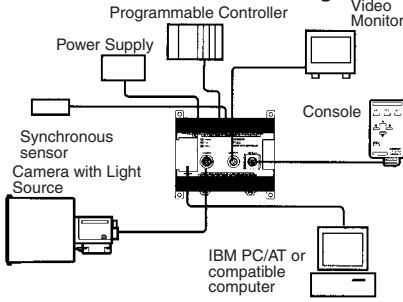
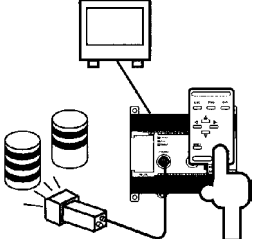
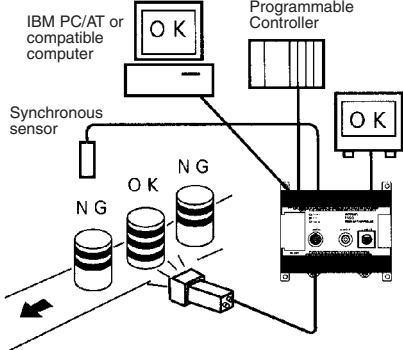
Step	Manual
<p>1: Unit Connections and Wiring</p>  <p>Programmable Controller</p> <p>Video Monitor</p> <p>Power Supply</p> <p>Console</p> <p>Synchronous sensor</p> <p>Camera with Light Source</p> <p>IBM PC/AT or compatible computer</p>	<p>Setup Manual</p>
<p>2: Setting Measurement Conditions</p> 	<p>Expert Menu Operation Manual</p>
<p>3: Confirming Operation, Measuring Objects, and Outputting Results</p>  <p>IBM PC/AT or compatible computer</p> <p>Programmable Controller</p> <p>Synchronous sensor</p> <p>NG</p> <p>OK</p> <p>NG</p> <p>OK</p>	

F150-C10E3DRT

The F150-C10E-3-DRT can operate as a CompoBus/D Slave.

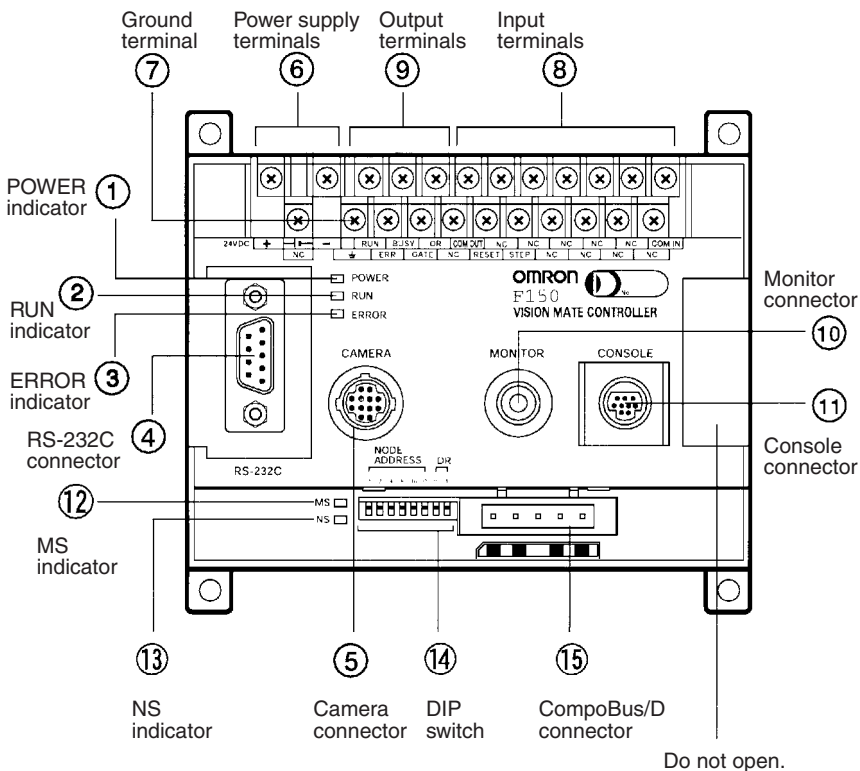

- ① **POWER Indicator**
Lit while power is ON.
- ② **RUN Indicator**
Lit in RUN mode.
- ③ **ERROR Indicator**
Lit when an error occurs.
- ④ **RS-232C Connector**
Connects the F150 to a computer, Programmable Controller, or other external device.
- ⑤ **Camera Connector**
Connects to the Camera.
- ⑥ **Power Supply Terminals**
Wired to the power supply.
- ⑦ **Ground Terminal**
Wired to the ground.
- ⑧ **Input Terminals**
Wired to external devices, such as synchronous sensors or inputs from a Programmable Controller.
- ⑨ **Output Terminals**
Wired to external devices, such as synchronous sensors or outputs to a Programmable Controller.
- ⑩ **Monitor Connector**
Connects to the video monitor.
- ⑪ **Console Connector**
Connects to the Console.
- ⑫ **MS (Module Status) Indicator**
Indicates the status of the F150 in CompoBus/D communications. Lit in green when the F150 is operating normally.
- ⑬ **NS (Network Status) Indicator**
Indicates the status of the network in CompoBus/D communications. Lit in green when the network is operating normally.
- ⑭ **DIP Switch**
Used to set the node address and baud rate.
- ⑮ **CompoBus/D Connector**
Connects the communications cable of the CompoBus/D network.

2-3 Connections

Connect the basic components as shown in the following diagram. Details are provided later in this section.

-  **Caution** Turn OFF the power to the Controller before connecting or disconnecting cables. Connecting or disconnecting cables with power turned ON can damage peripheral devices. If the Two-camera Unit is connected, turn OFF the power to the Two-camera Unit as well as the power to the F150 itself before connecting or disconnecting cables.

Power Supply → **p. 14**
 (OMRON's S82K-01524 and S8VS-06024 recommended.)

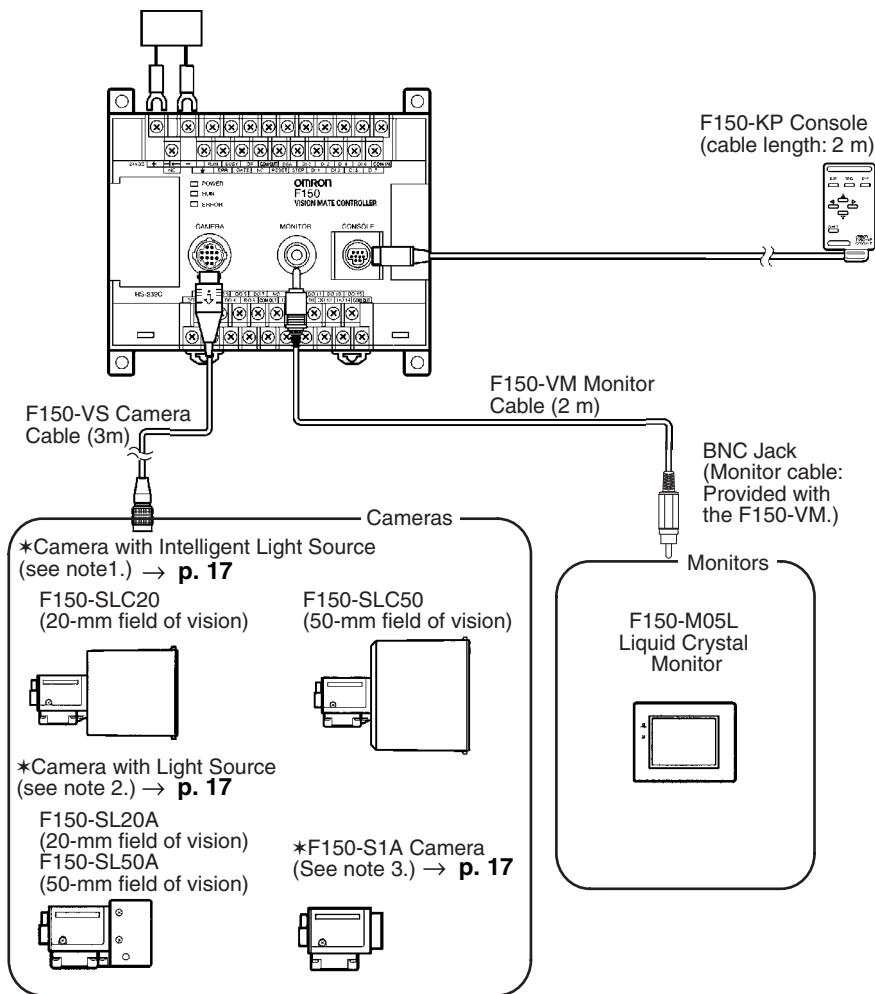

- Note**
1. An F150-LTC20/LTC50 Intelligent Light Source (with dedicated lens) is attached to the F150-S1A Camera.
 2. An F150-LT10A Light Source (with dedicated lens) is attached to the F150-S1A Camera.
 3. If the field of vision is too small or too big, use the F150-S1A Camera with a normal CCTV lens and light source. → **p. 20**

Connecting to Two Cameras

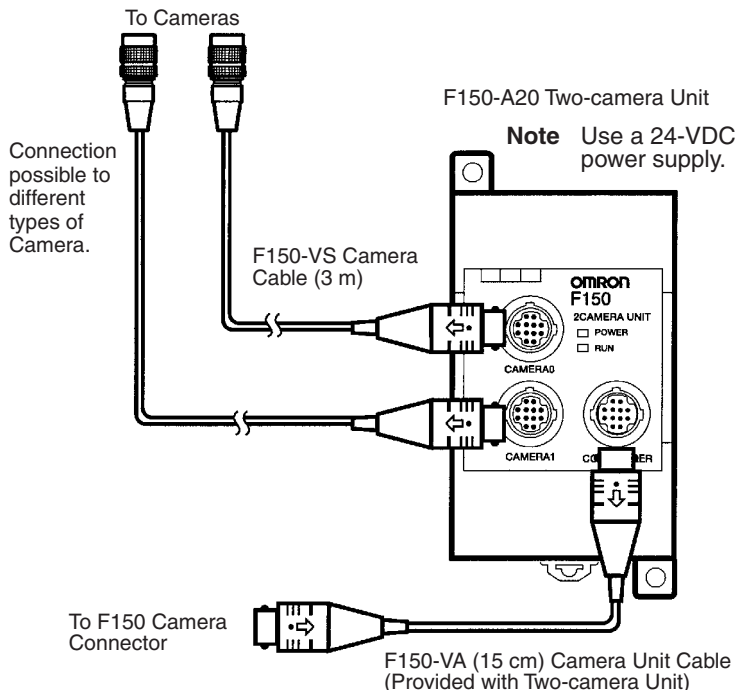

2-4 Power Supply and Ground

Wire the power supply and the ground to the top terminal block, and tighten the screws to a torque of between 0.5 and 0.6 N·m.

After wiring, confirm that wiring and screw tightening have been performed properly.

Caution Cover the terminal blocks with the Terminal Block Protection Covers.

2-4-1 Crimp Terminals and Cables

The terminal block uses M3 terminal screws. Use appropriate crimp terminals for M3 screws, as shown below.

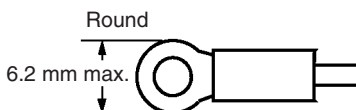

Applicable wire size: Insulated wire of 1.31 to 1.65 mm² (AWG16 to AWG15)

2-4-2 Protective Conductor (Earth) Wiring

Wire the ground as shown in the following diagram.

Caution Use an appropriate ground. An insufficient ground can affect F150 operation or result in damage to F150 components.

- To avoid damage to the equipment, do not share the protective conductor wiring with any other devices nor wire the protective conductor terminal to the girder. Be sure to wire the protective conductor of the equipment independently.
- Keep the ground line as short as possible.

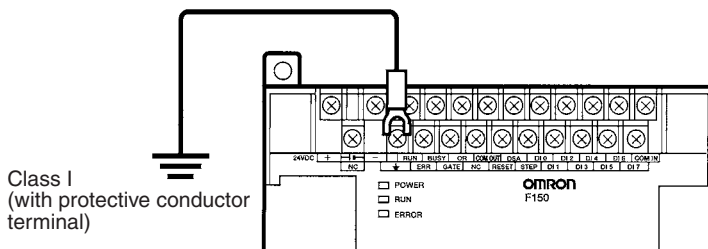

2-4-3 Wiring the Power Supply

Caution Use DC power supplies with safe extra low-voltage circuits that prevent occurrences of high voltages in the main F150 power supply and power supplies for the terminal blocks.

Power Supplies

Use a power supply with the following specifications. We recommend using OMRON's S82K-01524 Power Supply.

Item	Specification
Output current	0.6 A min.
Power supply voltage	24 VDC +10%/−15%

When connecting the F150, Two-camera Unit, and F150-M05L LCD Monitor to a single power supply, use a power supply that meets the following specifications. We recommend using OMRON's S8VS-06024 Power Supply.

Item	Specification
Output current	1.6 A min.
Power supply voltage	24 VDC +10%/-15%

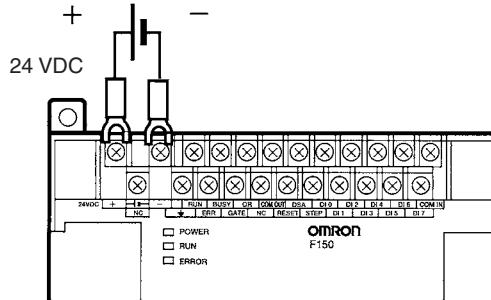

- Note**
1. Wire the Power Supply Unit independently of other devices. In particular, keep the power supply wired separately from inductive loads.
 2. Keep the power supply cable as short as possible (less than 10 m).
 3. If UL recognition is required, use a UL class II power supply.

2-5 Cameras with Light Sources

A dedicated lens and light source have been attached to the F150 Camera (F150-S1A) to produce "Cameras with Light Sources." The Light Source and Lens are a single unit and are thus compact and easy to mount.

Cameras with F150-LT10A Light Source

The F150-S1A Cameras are shipped with a Lens and Light Source attached.



Field of vision	Model
20 mm	F150-SL20A
50 mm	F150-SL50A

Cameras with Intelligent Light Source

The F150-S1A Cameras are shipped with a Lens and Intelligent Light Source attached.

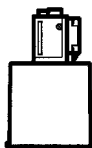

Field of vision	Model
20 mm	F150-SLC20
50 mm	F150-SLC50

The Intelligent Light Source incorporates a DIP switch for specifying unit numbers. When using the Two-camera Unit, set the DIP switch on the Light Source connected to Camera 1 to 1.

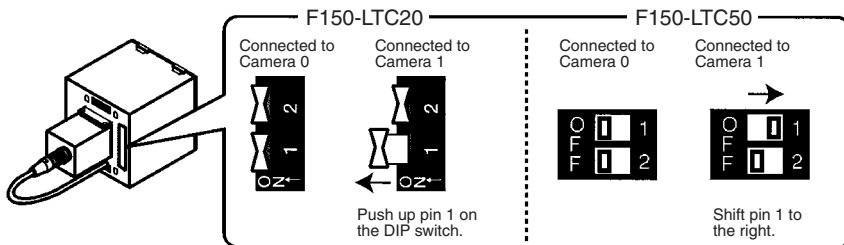

Camera Only

The same Camera is also available without a lens and light source so that standard CCTV lenses and lights can be used. Use C-mount lenses.



Camera	Model
Camera	F150-S1A

Caution The F150-S1A Camera must be used with the F150. Using other Cameras can damage the F150 or the Camera.

Distance from Measurement Object

The Camera must be mounted at a distance from the measurement object where it can correctly view the object.

- Note**
1. The Lens focus is fixed and the distance must be adjusted each time the Lens or Camera is changed because the field of vision and focus vary from Lens to Lens.
 2. The camera's set distance is an approximate value. The camera's mounting allows it to be adjusted slightly nearer to or farther from the object.

F150-SL20A/SL50A

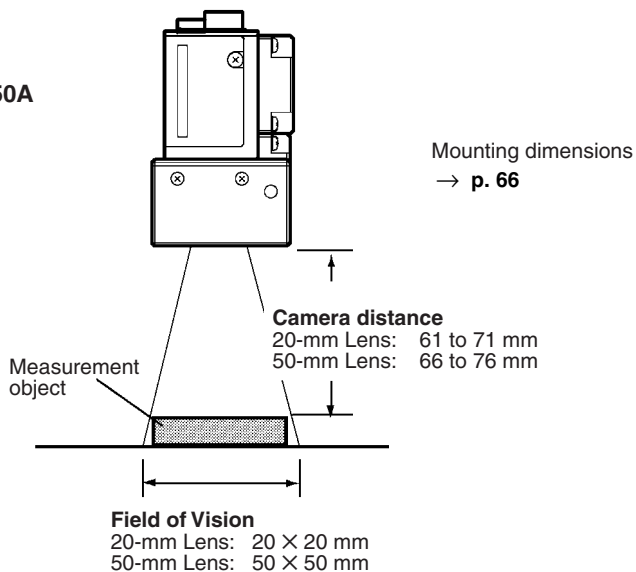

F150-SLC20

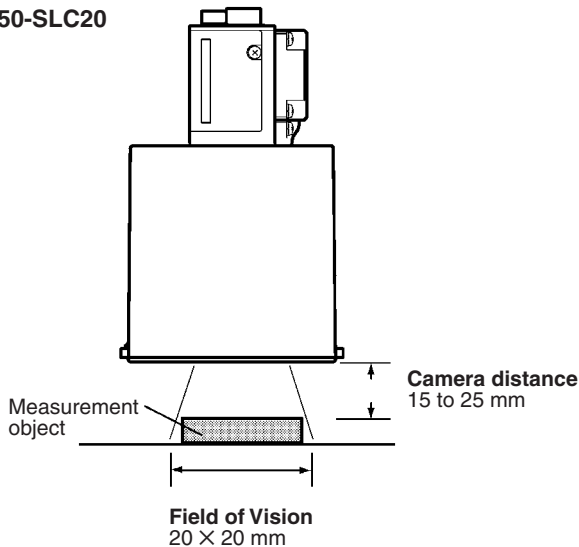

F150-SLC50

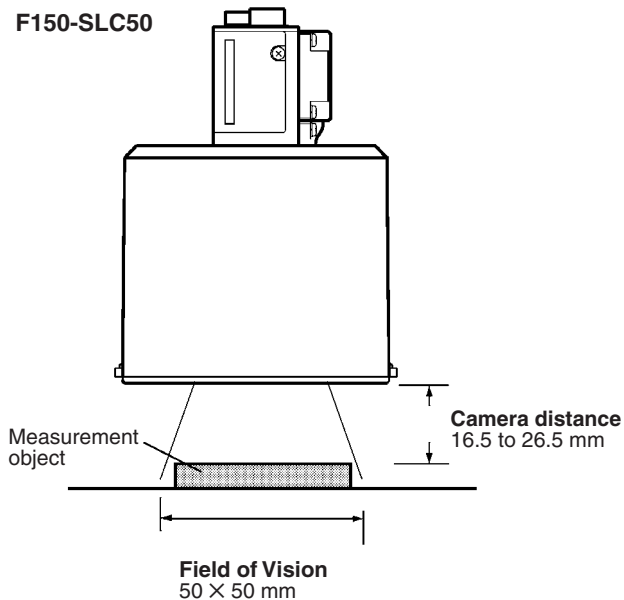

If the object size and field of vision are incompatible, attach a standard CCTV lens and light source to the Camera.

→ p. 20

2-6 CCTV Lens

When using a F150-S1A Camera (without a light source), refer to the following graph to select the appropriate Lens and Extension Tube. The lens will differ depending on the size of the measurement object and the distance from the Camera.

Note The CCTV Lens and Extension Tubes described in this section are not yet released.

2-6-1 Optical Chart

The values in the following chart are approximations, and the Camera must be adjusted after it is mounted.

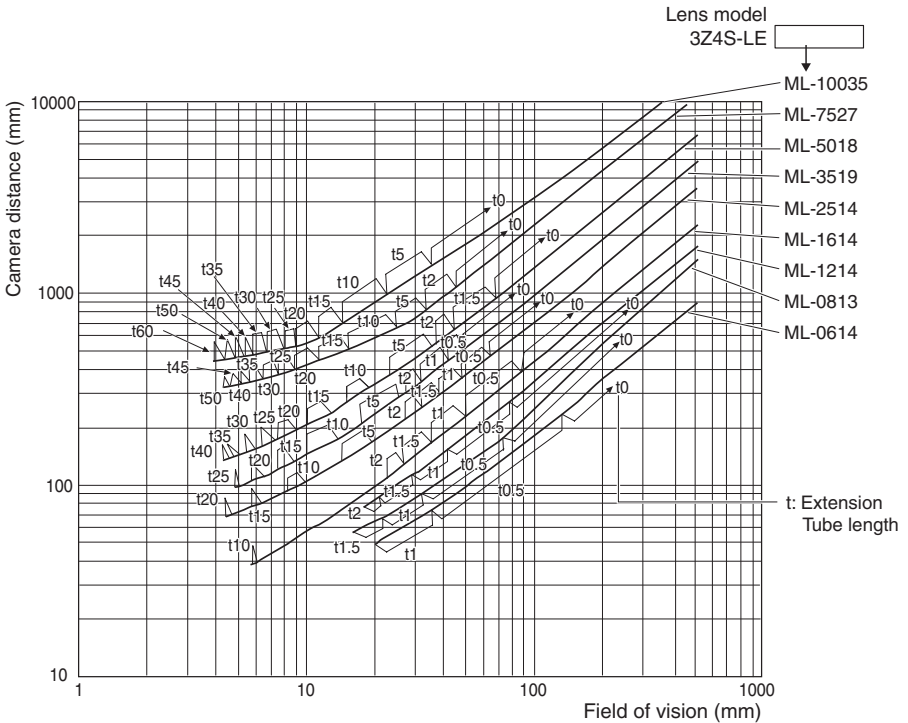

The X axis of the graph shows field of vision L (mm), and the Y axis shows the camera distance A (mm). The curves on the graph indicate different lenses, and the "t" values indicates the lengths of the Extension Tubes.

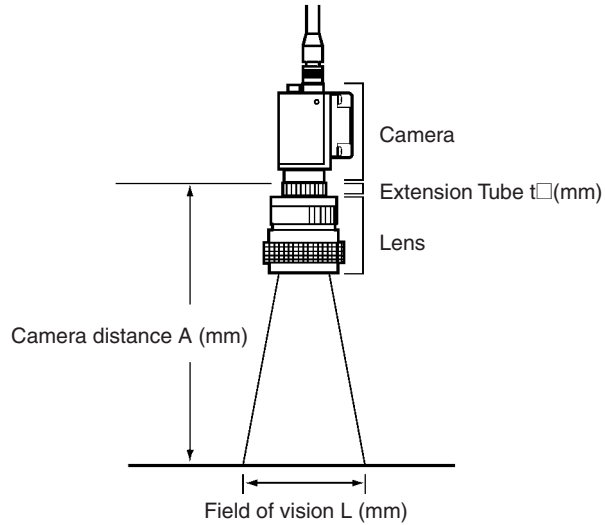

2-6-2 Lens

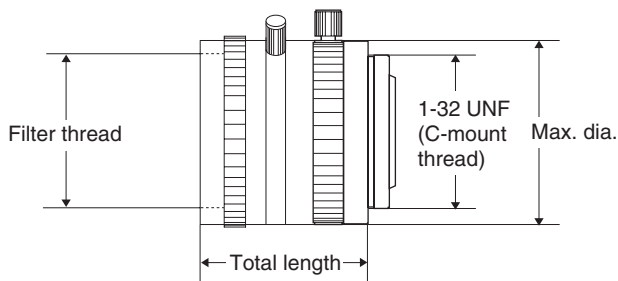

Lens	Focal length	Bright-ness	Maximum outer diameter	Total length	Filter size
3Z4S-LE ML-0614	6 mm	F1.4	30 mm dia.	30 mm	M27 P0.5
3Z4S-LE ML-0813	8 mm	F1.3	30 mm dia.	34.5 mm	M25.5 P0.5
3Z4S-LE ML-1214	12 mm	F1.4	30 mm dia.	34.5 mm	M27 P0.5
3Z4S-LE ML-1614	16 mm	F1.4	30 mm dia.	24.5 mm	M27 P0.5
3Z4S-LE ML-2514	25 mm	F1.4	30 mm dia.	24.5 mm	M27 P0.5
3Z4S-LE ML-3519	35 mm	F1.9	30 mm dia.	29 mm	M27 P0.5
3Z4S-LE ML-5018	50 mm	F1.8	32 mm dia.	37 mm	M30.5 P0.5
3Z4S-LE ML-7527	75 mm	F2.7	32 mm dia.	42.5 mm	M30.5 P0.5
3Z4S-LE ML-10035	100 mm	F3.5	32 mm dia.	43.9 mm	M30.5 P0.5

2-6-3 Extension Tubes

One or more Extension Tubes are inserted between the lens and the Camera to focus the Camera image. Use a combination of one or more of the seven sizes of tube to achieve the required length.

- Note**
- Do not use the 0.5-mm, 1.0-mm, and 2.0-mm Extension Tubes attached to each other. Since these Extension Tubes are placed over the threaded section of the Lens or other Extension Tube, the connection may loosen when more than one 0.5-mm, 1.0-mm, or 2.0-mm Extension Tube are used together.
 - Reinforcement may be required for combinations of Extension Tubes exceeding 30 mm if the Camera is subject to vibration.

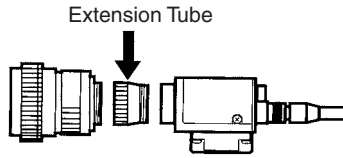

Model	Maximum outer diameter	Length
3Z4S-LE ML-EXR	30 dia.	Set of 7 tubes 0.5 mm, 1 mm, 2 mm, 5 mm, 10 mm, 20 mm, and 40 mm



2-7 Lighting

A stable image must be obtained to ensure accurate inspection. Use appropriate lighting for the application and the measurement object if using the F150-S1A Camera.

2-7-1 Lighting Methods

Back Lighting

A stable, high-contrast image can be obtained using back lighting.

Applications: Inspection of exterior shape or positioning inspection

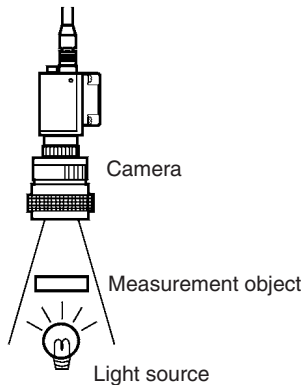

Reflected Lighting

Ring Lights

Light is shone uniformly on the measurement object.

Applications: Surface inspections

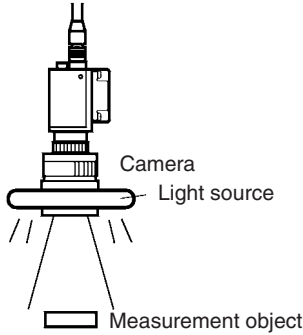

Oblique Lighting

Detection can be made utilizing the difference in regular and diffuse reflected light.

Applications: Inspections for surface gloss

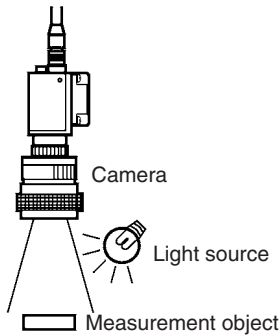

Coaxial Lighting

A stable image can be obtained with few shadows from uneven surfaces on the measurement object.

Applications: Surface inspections, positioning, and hole inspections of comparatively small objects

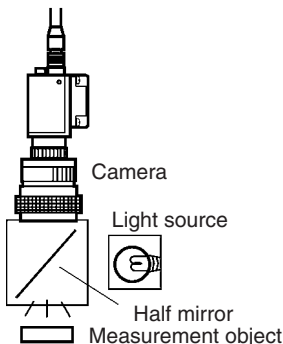

2-8 Two-camera Unit

By connecting the Two-camera Unit, two Cameras can be connected to one F150 and thus images can be taken from two Cameras at the same time.

2-8-1 Connecting to the Power Supply

Use a 24-VDC power supply. Specifications of crimp terminals and cables are the same as those for the F150 Power Supply.
→ p. 14

Note If the F150 and the Two-camera Unit need to be started sequentially, turn ON the Two-camera Unit first and then turn ON the F150. If they are turned ON in the reverse order, image data may not be read correctly.

2-8-2 Connecting to the F150

Connect to the F150 using the F150-VA Camera Unit Cable provided with the Two-camera Unit.

2-8-3 Connecting to Cameras

Connect to the Cameras using F150-VS Camera Cables.

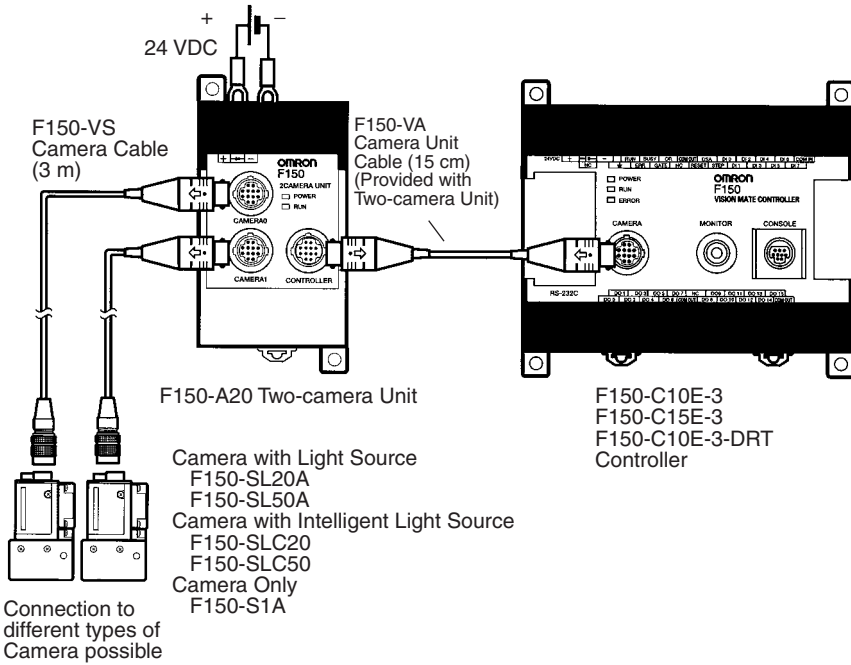

2-9 Mounting the Controller

The Vision Mate Controller can be mounted to DIN Track or a flat surface.

2-9-1 Mounting to DIN Track

The Vision Mate Controller can be easily mounted to or removed from 35-mm DIN Track.

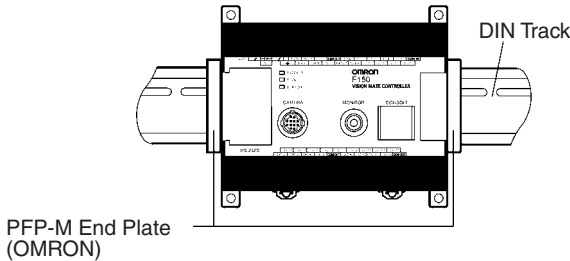

The following DIN Tracks are available from OMRON.

Model	Length
PFP-100N	1 m
PFP-50N	50 cm
PFP-100N2	1 m

Connecting to the Two-camera Unit

Install the Two-camera Unit to the left of the F150 using the Camera Unit Cable (15 cm).

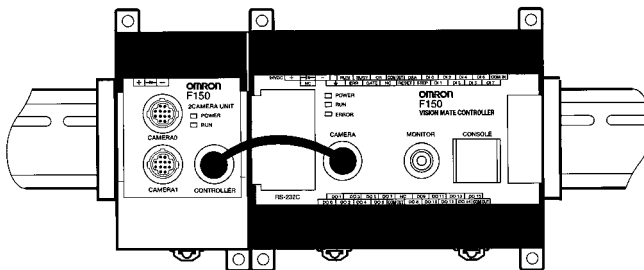

Mounting the Controller

Hook the Controller into the DIN Track as shown in the diagram and then press in at the bottom until the Controller locks into place.

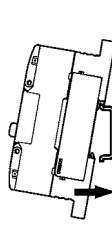

Removing the Controller

Use a screwdriver to pull the hook down and then pull out the Controller from the bottom.

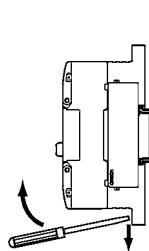

2-9-2 Mounting on a Flat Surface

Mount the Controller using the holes and dimensions shown in the following diagram.

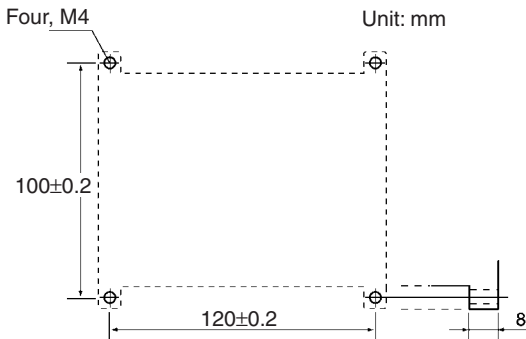

SECTION 3

Terminal Blocks

This section describes how to connect the terminal blocks. The F150 can input measurement triggers and output measurement results through these terminal blocks. For details on setting communications specifications and I/O formats, refer to the relevant operation manuals.

3-1	Crimp Terminals and Cables	30
3-2	Specifications	30
3-3	Terminals	31

3-1 Crimp Terminals and Cables

The terminal block uses M3 terminal screws. Use appropriate crimp terminals for M3 screws, as shown below. Tighten the screws to a torque of between 0.5 and 0.6 N-m.

Confirm that wiring and tightening have been done properly. Use a cable length not exceeding 30 m.

⚠ Caution Cover the terminal blocks with the Terminal Block Protection Covers after wiring.

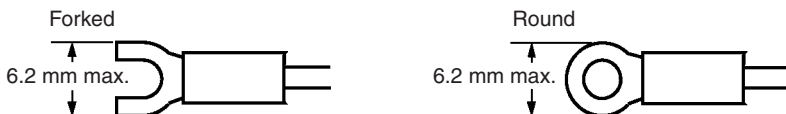

Applicable wire size: Insulated wire of 1.31 to 1.65 mm² (AWG16 to AWG15)

3-2 Specifications

⚠ Caution Use a DC power supply with a safe extra low-voltage circuit that prevents occurrences of high voltages in the power supplies for the terminal blocks.

Input Specifications

Item	F150-C10E-3, F150-C10E-3-DRT (NPN model)	F150-C15E-3 (PNP model)
Input voltage	12 to 24 VDC ±10%	
ON current	5 to 15 mA	
ON voltage	8.8 V max.	
OFF current	0.1 mA max.	
OFF voltage	4.5 V min.	
ON delay	RESET input: 10 ms max. Others: 0.5 ms max.	
OFF delay	RESET input: 15 ms max. Others: 0.7 ms max.	
Internal circuits		

Output Specifications

Item	F150-C10E-3, F150-C10E-3-DRT (NPN model)	F150-C15E-3 (PNP model)
Output voltage	12 to 24 VDC $\pm 10\%$	
Load current	45 mA max.	
ON residual voltage	2 V max.	
OFF leakage current	0.1 mA max.	
Internal circuits		

Note If UL recognition is required, use a UL class II power supply.

3-3 Terminals

The terminals on the terminal blocks are assigned as shown in the following diagrams and tables.

F150-C10E-3
F150-C15E-3

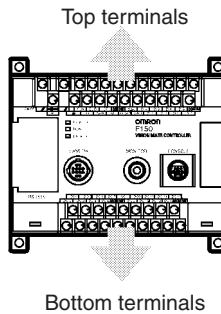

Top Terminals

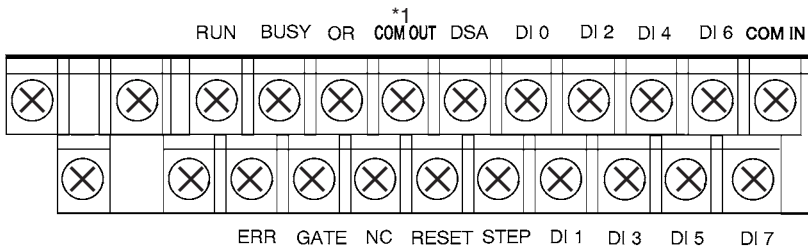

Name/Application		Name/Application	
RUN		ERR	Error output
BUSY		GATE	
OR		NC	Not connected
COM OUT (*1)	For RUN, ERR, BUSY, GATE, and OR	RESET	Resets F150
DSA	Command inputs	STEP	
DI 0		DI 1	Command inputs
DI 2		DI 3	
DI 4		DI 5	
DI 6		DI 7	
COM IN		---	

Bottom Terminals

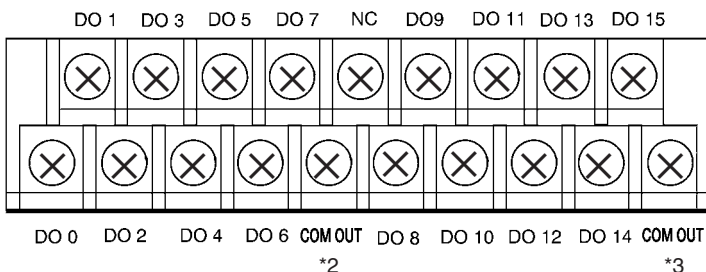

Name/Application		Name/Application	
DO 1	Measurement results output	DO 0	Measurement results output
DO 3		DO 2	
DO 5		DO 4	
DO 7		DO 6	
NC	Not connected	COM OUT (*2)	For DO 0 to DO 7
DO 9	Measurement results output	DO 8	Measurement results output
DO 11		DO 10	
DO 13		DO 12	
DO 15		DO 14	
---		COM OUT (*3)	For DO 8 to DO 15

⚠ Caution Do not input the RESET input immediately after turning ON the power. When using RESET input to synchronize execution timing, wait at least 1 s after turning ON the F150 power supply before turning ON the RESET terminal.

⚠ Caution Do not reverse the connections of the signal terminals and COM terminals.

F150-C10E-3-DRT

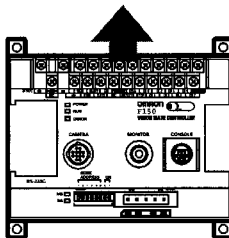
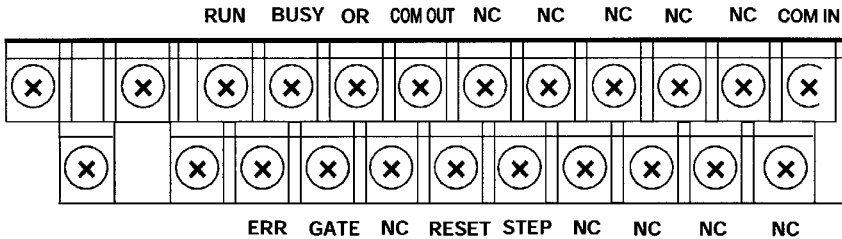

Name/Application		Name/Application	
RUN		ERR	Error output
BUSY		GATE	
OR		NC	Not connected
COM OUT		RESET	Resets F150
NC	Not connected	STEP	
NC		NC	Not connected
NC		NC	
NC		NC	
NC		NC	
COM IN		---	

 **Caution** Do not input the RESET input immediately after turning ON the power. When using RESET input to synchronize execution timing, wait at least 1 s after turning ON the F150 power supply before turning ON the RESET terminal.

 **Caution** Do not reverse the connections of the signal terminals and COM terminals.

SECTION 4

RS-232C Connection

This section describes how to connect the RS-232C port. The F150 can input measurement triggers and output measurement results through this port. For details on setting communications specifications and I/O formats, refer to the relevant operation manuals.

4-1	Connector	36
4-2	Wiring	37
4-3	Connection	38

4-1 Connector

Use an appropriate 9-pin D-SUB female connector. The pin numbers and names are shown below.

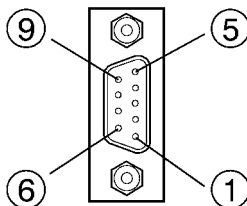

Pin	Signal	Name
1	FG (GND)	Frame ground
2	SD (TXD)	Send Data
3	RD (RXD)	Receive Data
4	RS (RTS)	Request to Send
5	CS (CTS)	Clear to Send
6	NC	Not connected
7	NC	Not connected
8	NC	Not connected
9	SG (GND)	Signal ground

The following plug and hood are recommended and are available from OMRON.

Model	Model No.
Plug	XM2A-0901
Hood	XM2S-0911

4-2 Wiring

Use only shielded RS-232C cable.

Standard Connections

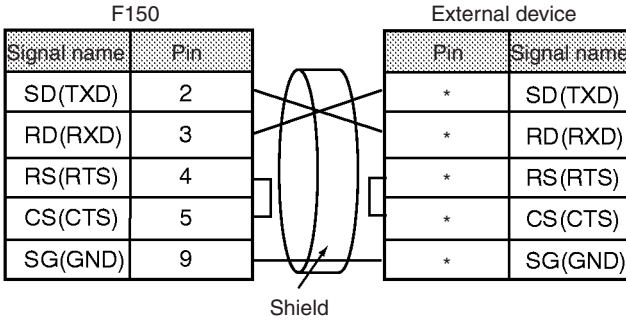

Connections for RS/CS Control

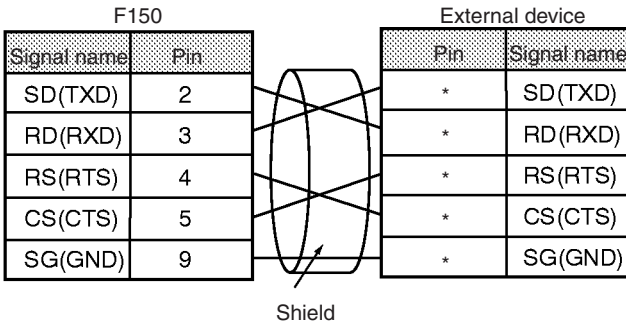

Note Pin numbers on the external device will depend on the device being connected. Refer to the manual for the device being connected.

SECTION 5

CompoBus/D Connections

This section describes how to connect the F150-C10E-3-DRT Vision Sensor as a CompoBus/D Slave and provides information such as connector pin allocations, node number settings, and baud rate settings.

Refer to the *CompoBus/D (DeviceNet) Operation Manual (W267-E1-4)* for details on CompoBus/D communications specifications.

Refer to the *Expert Menu Operation Manual* for details on setting the Vision Sensor's communications specifications and changing the I/O format.

5-1	Overview	40
5-2	Communications Specifications	44
5-3	DIP Switch Settings	45
5-4	Connector Pin Allocation	47
5-5	LED Indicators	48
5-6	Multi-vendor Applications	48

5-1 Overview

CompoBus/D is a multi-bit, multi-vendor network that conforms to DeviceNet open field network specifications. The F150-C10E-3-DRT Vision Sensor operates as a CompoBus/D Slave and data is automatically transferred between the Slave and Master by remote I/O communications.

The number of I/O bytes handled by the Vision Sensor depends upon the communications specifications settings, so be sure to set the Vision Sensor's communications specifications before registering the Master's scan list.

Refer to the *Expert Menu Operation Manual* for details on setting the Vision Sensor's communications specifications and changing the I/O format.

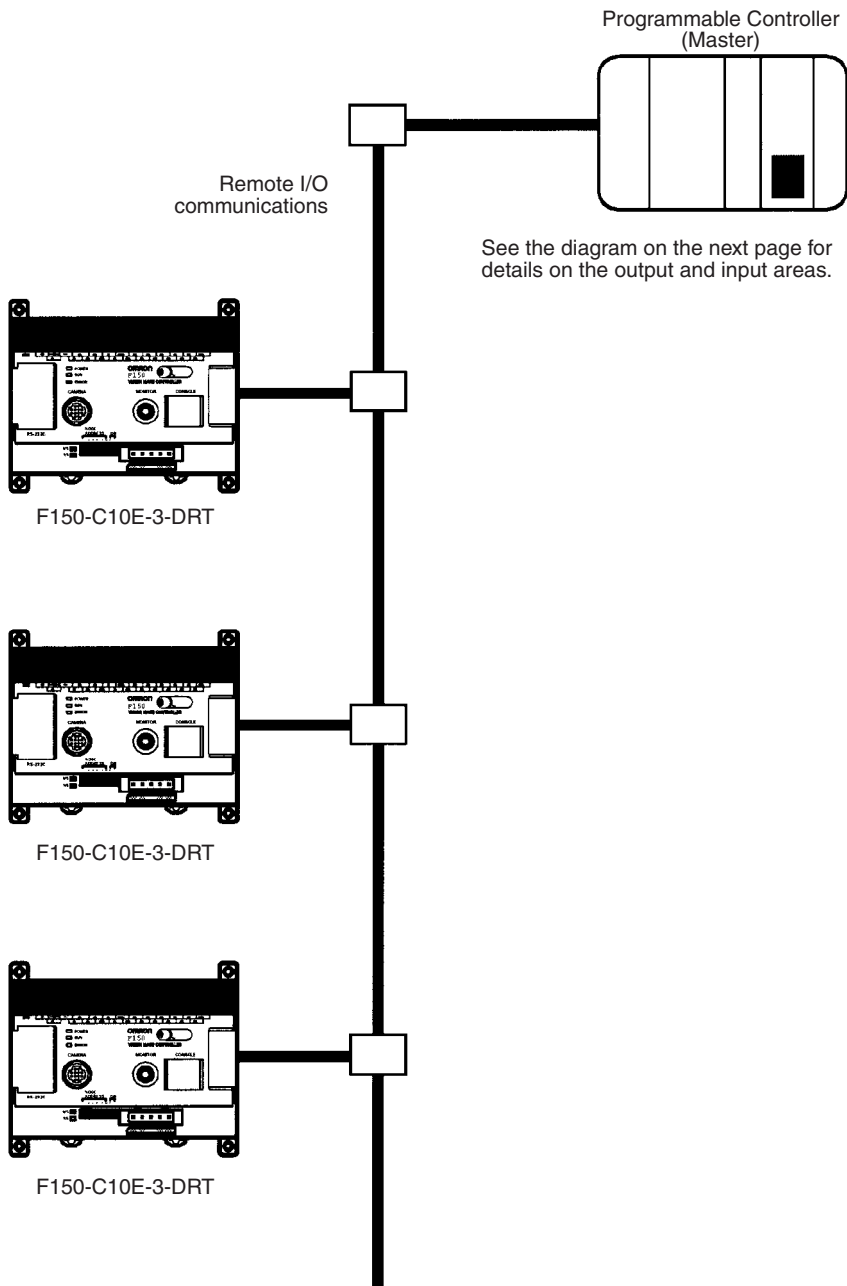

Output Area

Write commands are directed to the F150 in this area. The number of bytes in the area depends upon the input mode (basic or expand) that is selected.

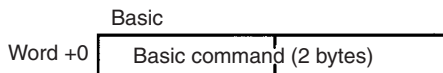

Only a few words are occupied. Commands such as the measurement and scene change commands can be used.

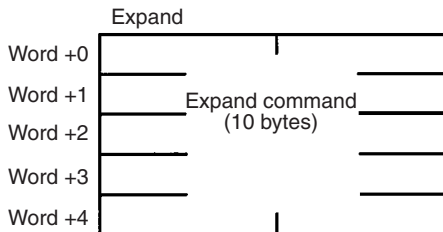

A variety of commands other than the measurement command can be used, such as parameter setting and reading commands. Various F150's functions can be used.

Input Area

The measurement results (execution results) from the F150 are output to this area.

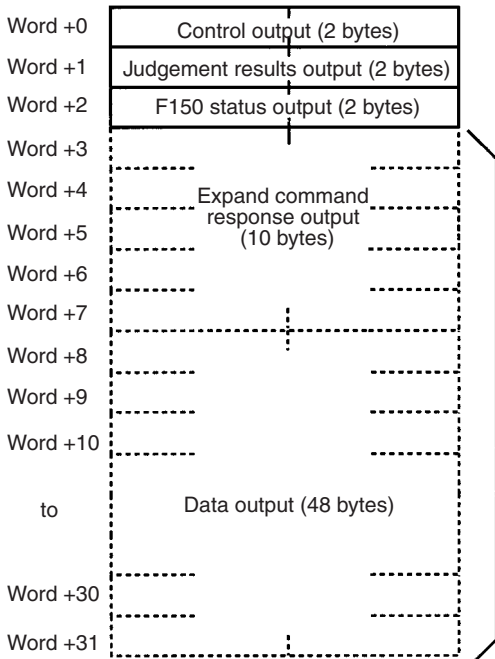

These outputs can be enabled or disabled. When the "expand command response output" is disabled, the data output will be shifted up to word +3.

5-2 Communications Specifications

Item		Specification
Communications protocol		DeviceNet
Supported connections (see note 1) (communications)		Master-Slave: Remote I/O communications and explicit message/communications
Connection formats (see note 2)		Multi-drop and T-branch connections can be combined (for trunk or drop lines)
Baud rate		125K bps, 250K bps, or 500K bps (Set on the DIP switch.)
Communications media		Special 5-conductor cable (2 signal lines, 2 power lines, 1 shield)
Communications distances	500K bps	Network length: 100 m max. (see note 3) Drop line length: 6 m max. Total drop line length: 39 m max.
	250K bps	Network length: 250 m max. (see note 3) Drop line length: 6 m max. Total drop line length: 78 m max.
	125K bps	Network length: 500 m max. (see note 3) Drop line length: 6 m max. Total drop line length: 156 m max.
Communications power supply		Power supply voltage:11 to 25 VDC Current consumption:55 mA max.
Node number		0 to 63 (Set on the DIP switch.)
Words used in Master (see note 4)	Output area	1 word (2 bytes) or 5 words (10 bytes) (Set to 1 word when shipped.)
	Input area	3 words (6 bytes), 8 words (16 bytes), 27 words (54 bytes), or 32 words (64 bytes) (Set to 3 words when shipped.)
Error control checks		CRC error check

- Note**
1. Only remote I/O communications are supported in the Vision Sensor's Expert Menu. Explicit message communications are not supported.
 2. A terminator must be connected at each end of the trunk line.
 3. These values are valid when thick cable is used for the trunk line. The maximum network length is 100 m max. when thin cable is used.
 4. Set the number of words in the Menu. Reset the entire network after changing these settings.

5-3 DIP Switch Settings

The node address and baud rate are set on the DIP switch. Be sure to turn OFF the power supply (including the communications power supply) before changing DIP switch settings.

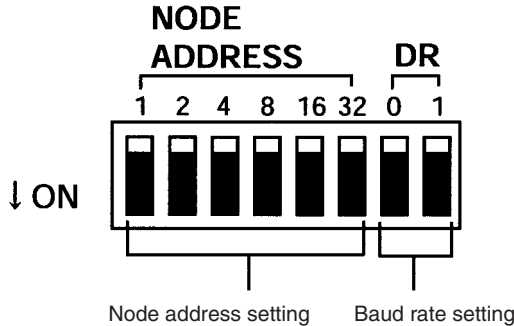

Note Set the same baud rate on all nodes (Master and Slaves) in the network. If the F150 is not set to the correct baud rate, it will be unable to participate in the network and communications errors may occur in communications between nodes with correct node address settings.

Node Address Setting (0 to 63)

Set the node address in binary with pins 1 through 6. These pins have values of 1, 2, 4, 8, 16, and 32 (left to right). The node address is set to 0 when the Sensor is shipped.

The following diagram shows the node address set to 10. The pins with values 2 and 8 are turned ON.

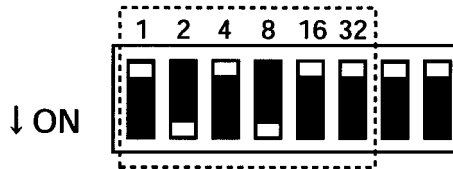

Baud Rate Setting (125K bps, 250K bps, or 500K bps)

Pins 7 and 8 set the baud rate as shown in the following diagrams.

- 125K bps (factory setting)

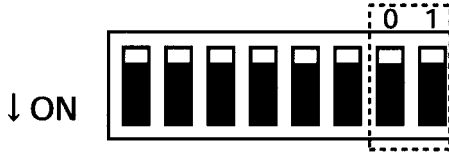

- 250K bps

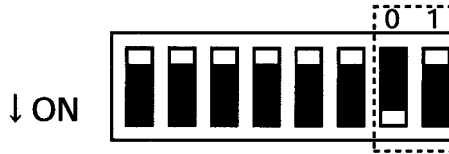

- 500K bps



5-4 Connector Pin Allocation

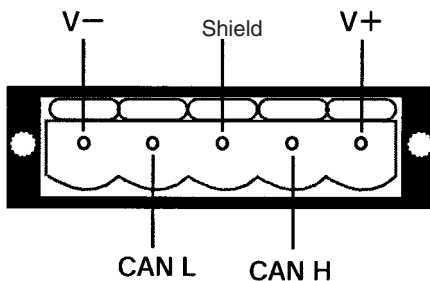
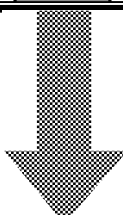
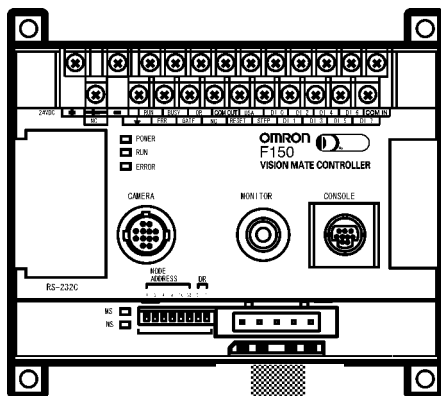

Name	Function	Color
V-	Power supply line (-)	Black
CAN L	Communications data (Low)	Blue
Shield	Shield	---
CAN H	Communications data (High)	White
V+	Power supply line (+)	Red

Refer to the *CompoBus/D (DeviceNet) Operation Manual* for details on assembling a communications cable.

- Note**
1. Turn OFF the power supply before connecting or disconnecting the cable. Peripheral devices may be damaged if the cable is connected or disconnected with the power ON.
 2. Securely tighten the connector screws.

5-5 LED Indicators

The status of CompoBus/D communications is indicated by the MS and NS indicators.

MS (Module Status) Indicator

The MS indicator shows the status of node (F150) itself. The indicator will be lit green when the F150 is operating normally.

NS (Network Status) Indicator

The NS indicator shows the status of network. The indicator will be lit green when the network is operating normally.

Note The MS and NS indicators are lit in green or red. The status of these indicators (lit, flashing, or not lit) can be used to determine what error has occurred.

→ p. 58

5-6 Multi-vendor Applications

Use the Vision Sensor's specifications as well as the Device Protocol and Object Mounting information shown in the following tables when the F150-C10E-3-DRT is connected to another company's Master.

Device Protocol

General data	Compatible DeviceNet Specifications	Volume I - Release 2.0 Volume II - Release 2.0
	Vendor name	OMRON Corporation, vendor ID = 47
	Device type	Generic, protocol number = 0
	Product code	205
Physical conformance data	Network current consumption	55 mA max.
	Connector type	Open plug
	Physical insulation	Yes
	Supported indicators	Module, Network
	MAC ID setting	DIP switch
	Default MAC ID	0
	Supported baud rates	125K bps, 250K bps, and 500K bps
Communications data	Predefined Master/Slave connection set	Group 2 only server
	Dynamic connection support (UCMM)	No
	Explicit message fragmentation support	Yes

Object Mounting**Identity Object (0x01)**

Object class	Attribute	Not supported
	Service	Not supported

Item		ID content	Get (read)	Set (write)	Value
Object instance	Attribute	1 Vendor	Yes	No	47
		2 Product type	Yes	No	0
		3 Product code	Yes	No	205
		4 Revision	Yes	No	2.1
		5 Status (bits supported)	Yes	No	Bit 0 and bit 10
		6 Serial number	Yes	No	Unique for each Unit
		7 Product name	Yes	No	F150-C10E-3
		8 State	No	No	---

Item		DeviceNet service	Parameter option
Object instance	Service	05 Reset	No
		0E Get_Attribute_Single	No

Message Router Object (0x02)

Object class	Attribute	Not supported
	Service	Not supported
Object instance	Attribute	Not supported
	Service	Not supported
Vendor specification addition		No

DeviceNet Object (0x03)

Item		ID content	Get (read)	Set (write)	Value
Object instance	Attribute	1 Revision	Yes	No	02 (hexadecimal)

Item		DeviceNet service	Parameter option
Object class	Service	0E Get_Attribute_Single	No

Item		ID content	Get (read)	Set (write)	Value
Object instance	Attribute	1 MAC ID	Yes	No	---
		2 Baud rate	Yes	No	---
		3 BOI	Yes	No	00 (hexadecimal)
		4 Bus Off counter	Yes	No	---
		5 Allocation information	Yes	No	---
		6 MAC ID switch changed	No	No	---
		7 Baud rate switch changed	No	No	---
		8 MAC ID switch value	No	No	---
		9 Baud rate switch value	No	No	---

Item		DeviceNet service	Parameter option
Object instance	Service	0E Get_Attribute_Single	No
		4B Allocate_Master/Slave_Connection_Set	No
		4C Release_Master/Slave_Connection_Set	No

Assembly Object (0x04)

Object class	Attribute	Not supported
	Service	Not supported

Item	Section	Information	Max. number of instances
Object instance 1	Instance type	Static I/O	1

Item		Content	Get (read)	Set (write)	Value
Object instance 1	Attribute	1 Number of Members in List	No	No	---
		2 Members List	No	No	---
		3 Data	Yes	Yes	---

Item		DeviceNet service	Parameter option
Object instance 1	Service	0E Get_Attribute_Single	No
		10 Set_Attribute_Single	No

Connection Object (0x05)

Object class	Attribute	Not supported
	Service	Not supported
	Max. number of active connections	1

Item	Section	Information	Max. number of instances
Object instance 1	Instance type	Explicit Message	1
	Production trigger	Cyclic	---
	Transport type	Server	---
	Transport class	3	---

Item		ID content	Get (read)	Set (write)	Value
Object instance 1	Attribute	1 State	Yes	No	---
		2 Instance type	Yes	No	00 (hexadecimal)
		3 Transport class trigger	Yes	No	83 (hexadecimal)
		4 Produced connection ID	Yes	No	---
		5 Consumed connection ID	Yes	No	---
		6 Initial comm. characteristics	Yes	No	21 (hexadecimal)
		7 Produced connection size	Yes	No	FE00 (hexadecimal)
		8 Consumed connection size	Yes	No	FE00 (hexadecimal)
		9 Expected packet rate	Yes	Yes	---
		12 Watchdog time-out action	Yes	No	One of 01, 03
		13 Produced connection path length	Yes	No	0000
		14 Produced connection path	Yes	No	---
		15 Consumed connection path length	Yes	No	0000
		16 Consumed connection path	Yes	No	---
17 Production inhibit time	Yes	No	---		

Item		DeviceNet service	Parameter option
Object instance 1	Service	05 Reset	No
		0E Get_Attribute_Single	No
		10 Set_Attribute_Single	No

Item	Section	Information	Max. number of instances
Object instance 2	Instance type	Polled I/O	1
	Production trigger	Cyclic	---
	Transport type	Server	---
	Transport class	2	---

Item		ID content	Get (read)	Set (write)	Value
Object instance 2	Attribute	1 State	Yes	No	---
		2 Instance type	Yes	No	01 (hexadecimal)
		3 Transport class trigger	Yes	No	82 (hexadecimal)
		4 Produced connection ID	Yes	No	---
		5 Consumed connection ID	Yes	No	---
		6 Initial comm. characteristics	Yes	No	01 (hexadecimal)
		7 Produced connection size	Yes	No	See note 1.
		8 Consumed connection size	Yes	No	See note 2.
		9 Expected packet rate	Yes	Yes	---
		12 Watchdog time-out action	Yes	No	00
		13 Produced connection path length	Yes	No	0000 (no inputs) 0600 (with inputs)
		14 Produced connection path	Yes	No	No data (no inputs) 20_04_24_01_30_03 (with inputs)
		15 Consumed connection path length	Yes	No	0000 (no outputs) 0600 (with outputs)
		16 Consumed connection path	Yes	No	No data (no outputs) 20_04_24_01_30_03 (with outputs)
17 Production inhibit time	Yes	No	00		

- Note**
1. Indicates the number of input bytes used by the Slave. The leftmost and rightmost bytes are reversed. (For example, the produced connection size = 4000 when 64 bytes are used.)
 2. Indicates the number of output bytes used by the Slave. The leftmost and rightmost bytes are reversed. (For example, the consumed connection size = 4000 when 64 bytes are used.)

Item		DeviceNet service	Parameter option
Object instance 2	Service	05 Reset	No
		0E Get_Attribute_Single	No
		10 Set_Attribute_Single	No

Item	Section	Information	Max. number of instances
Object instance 3	Instance type	Bit strobed I/O	1
	Production trigger	Cyclic	---
	Transport type	Server	---
	Transport class	2	---

Item		ID content	Get (read)	Set (write)	Value
Object instance 3	Attribute	1 State	Yes	No	---
		2 Instance type	Yes	No	01 (hexadecimal)
		3 Transport class trigger	Yes	No	82 (hexadecimal)
		4 Produced connection ID	Yes	No	---
		5 Consumed connection ID	Yes	No	---
		6 Initial comm. characteristics	Yes	No	02 (hexadecimal)
		7 Produced connection size	Yes	No	See note.
		8 Consumed connection size	Yes	No	0800 (hexadecimal)
		9 Expected packet rate	Yes	Yes	---
		12 Watchdog time-out action	Yes	No	00
		13 Produced connection path length	Yes	No	0600
		14 Produced connection path	Yes	No	20_04_24_01_30_03
		15 Consumed connection path length	Yes	No	0000
		16 Consumed connection path	Yes	No	No data
17 Production inhibit time	Yes	No	00		

Note Indicates the number of input bytes used by the Slave. The leftmost and rightmost bytes are reversed. (For example, the produced connection size = 0800 when 8 bytes are used.)

With the bit-strobed interface, the maximum produced connection size is 8 bytes. A produced connection size of 8 bytes (0800) will be used if a higher value has been set for the number of input bytes with the user MPU; the set value will be used if it is 8 bytes or less.

Item		DeviceNet service	Parameter option
Object instance 3	Service	05 Reset	No
		0E Get_Attribute_Single	No
		10 Set_Attribute_Single	No

SECTION 6

Troubleshooting

This section lists the errors that may occur, along with their probable causes and countermeasure.

6-1	Connection Errors	56
6-2	Errors during Menu Operation	56
6-3	Terminal Block Errors	56
6-4	RS-232C Communications Errors.	57
6-5	Two-camera Unit.	57
6-6	LED Indicators (for F150-C10E-3-DRT)	58

6-1 Connection Errors

Problem	Probable cause
The POWER indicator is not lit.	The Power Supply is not connected properly.
	The supply voltage is not 24 VDC $+10\%$ / -15% .
The Monitor is blank.	The power to the Monitor is not ON.
	The Monitor Cable is not connected properly.
	The Monitor is malfunctioning.
	The power supply capacity is insufficient for the Monitor.
Cannot make key inputs from the Console.	The Console Cable is not correctly connected.
Camera images do not appear on the screen (for Cameras with Light Source).	The Camera Cable is not correctly connected.
	The lighting cable is not properly connected to the Camera.
Camera images do not appear on the screen (when a normal CCTV lens and lighting is used).	The lens cap has not been removed.
	The Camera Cable is not properly connected.
	The lens diaphragm is opened or closed too far.
	The shutter speed is not suitable.
	The lighting method is not suitable.
The indicators do not turn ON (for Cameras with Light Source).	The lighting cable is not correctly connected to the Camera.
	There is no power supply to the F150.
	The DIP switches on Intelligent Light Sources are not set correctly.
	When using the Two-camera Unit, set the Intelligent Light Source connected to Camera 0 to 0, and set the Intelligent Light Source connected to Camera 1 to 1.
The Monitor image is not clear.	There is electrical noise entering from the power supply or cables.
	The Monitor Cable is not correctly connected.

6-2 Errors during Menu Operation

Problem	Probable cause
The measurement results are not displayed on the Monitor.	The F150 is not in Monitor or Run mode.

6-3 Terminal Block Errors

Problem	Probable cause
Trigger signals (input signals) are not received.	The cables are not correctly wired.
	The signal line is disconnected.
	The F150 is not in Monitor or Run mode.

Problem	Probable cause
Signals cannot be output externally.	The trigger signal has not been input.
	The cables are not correctly wired.
	The signal line is disconnected.
	The F150 is not in Run mode.

6-4 RS-232C Communications Errors

Problem	Probable cause
No communications are possible.	The cables are not correctly wired.
	The communications specifications do not match those of the external device.
	The communications mode was not selected under System/Communications settings . Select Normal, Host link , or Menu operations under RS-232C/Operating mode .
The Unit operates well initially, but after a while there is no response from the F150.	The reception buffer on the external device (e.g., computer) is full. Check that settings allow the data to be properly received.
Cannot perform menu operations via RS-232C.	The communications mode was not selected as System/Communications settings/Menu operations .

6-5 Two-camera Unit

Problem	Probable cause
The LED indicator is not lit.	The power supply is not connected correctly.
	The supply voltage has dropped below the specified level (24 VDC +10%/–15%).
	The Two-camera Unit is not connected to the F150.

6-6 LED Indicators (for F150-C10E-3-DRT)

Indicator Status		Condition	Countermeasure
MS	NS		
Lit green	Lit green	Remote I/O communications in progress.	Communications are operating normally.
	OFF	Node number duplication check in progress.	Check for the following problems and restart the F150.
	Flashing green	Waiting for connection to be established by Master.	<ul style="list-style-type: none"> • Are the baud rate settings the same on the Master and F150? • Are the cable lengths (trunk and branch lines) within specifications? • Are any cables loose or broken? • Is there a terminator on each end of the trunk line? • Is there excessive noise in the network?
	Lit red	Node number duplication	Change the node number settings to eliminate the duplication and then restart the entire CompoBus/D network.
Bus off occurred. (Communications stopped due to excessive data errors.) Check for the following problems and restart the F150.			
Flashing red	Communications time-out occurred.	<ul style="list-style-type: none"> • Are the baud rate settings the same on the Master and F150? • Are the cable lengths (trunk and branch lines) within specifications? • Are any cables loose or broken? • Is there a terminator on each end of the trunk line? • Is there excessive noise in the network? 	
Lit red	OFF	Watchdog timer error occurred in the F150.	The F150 is faulty. Replace the F150.
Flashing red	OFF	Incorrect setting on the DIP switch or elsewhere.	Check the switch settings and restart the F150.

SECTION 7

Maintenance

This section provides information on maintenance and inspection.

7-1	Maintenance Parts and Replacement.	60
7-1-1	F150-SL20A/SL50A	60
7-1-2	F150-SLC20/SLC50	61
7-2	Regular Inspections.	62

7-1 Maintenance Parts and Replacement

Maintenance parts of the F150 are shown in the following table.

- Note**
1. The Light Source will gradually lose illumination if used for long periods (approx. 20% loss after 1,500 hours of use). Replace the Light Source after approx. 1,500 hours of use.
 2. Replace the Light Source if it is partially damaged or not fully functioning.

7-1-1 F150-SL20A/SL50A

Part	Model No.
20-mm Lens (20 mm × 20 mm)	F150-LE20
50-mm Lens (50 mm × 50 mm)	F150-LE50
Light Source	F150-LT10A

Note Not possible to connect to the previous F150-S1 Camera.

Replacing the Lens or Light Source

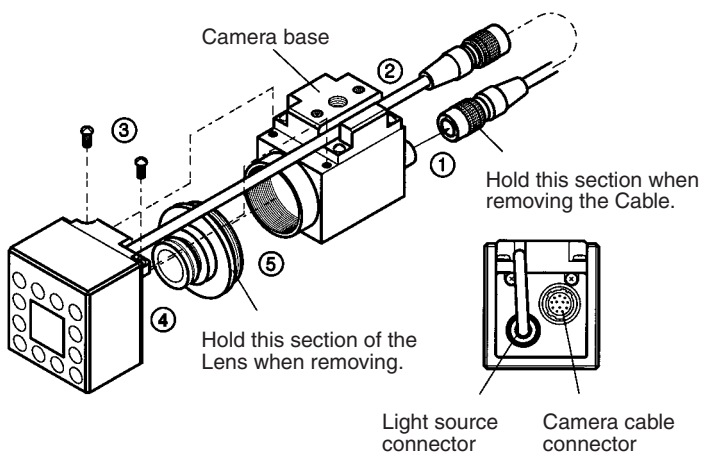

1. Disconnect the light cable from the light connector on the back of the Camera.
2. Remove the light cable from the slot in the camera base.
3. Remove the two screws securing the Light Source.
4. Remove the Light Source from the Camera.
5. Remove the Lens from the camera mount.

Note Follow these steps in the reverse order to mount the Lens and Light Source.

Caution Do not disassemble the Lens. Disassembly can damage the Lens.

7-1-2 F150-SLC20/SLC50

	Field of vision	Model No.
Lens	20 mm × 20 mm	F150-LE20
	50 mm × 50 mm	F150-LE50
Light Source	20 mm × 20 mm	F150-LTC20
	50 mm × 50 mm	F150-LTC50

Replacing the Lens or Light Source

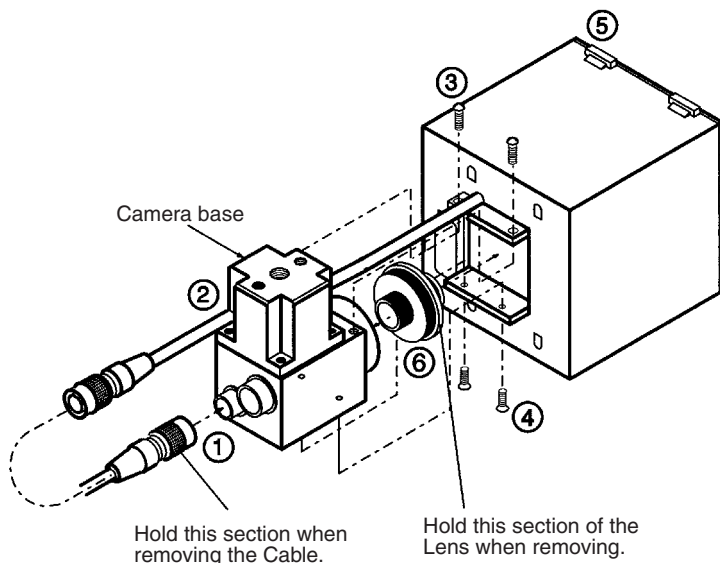

1. Disconnect the light cable from the light connector on the back of the Camera.
2. Remove the light cable from the slot in the camera base.
3. Remove the two screws securing the Light Source.
4. Remove the two screws securing the Light Source.
5. Remove the Light Source from the Camera.
6. Remove the Lens from the camera mount.

Note 1. Follow these steps in the reverse order to mount the Lens and Light Source.

2. If an Intelligent Light Source is not used, the screws in step 4 will be too long for the holes in the Camera. Use two M2×3 screws. The screws in step 3 are not required.

 **Caution** Do not disassemble the Lens. Disassembly can damage the Lens.

7-2 Regular Inspections

To maintain the F150 in the best condition, perform the following regularly.

- Lightly wipe off dirt with a soft cloth.
- Clean the Lens and indicators with a special Lens cloth or airbrush.

Inspection point	Details	Tools required
Power supply	The voltage measured at the power supply terminals on the terminal block must be 24 VDC $+10\%/_{-15\%}$.	Circuit tester
Ambient temperature	The operating ambient temperature inside the cabinet must be between 0 and 50°C.	Thermometer
Ambient humidity	The operating ambient humidity inside the cabinet must be between 35% and 85%.	Hygrometer
Installation	Each component must be firmly secured. Each cable connector must be correctly inserted and locked. The Cameras must be firmly secured. The camera Lens mounts must be firmly secured.	Phillips screw-driver
Indicators	All indicators must light when the power is turned ON.	---

 **Caution** Turn OFF the power and take safety precautions before conducting inspections. Electrical shock can result from attempting safety inspections with the power turned ON.

 **Caution** Do not use thinners or benzene. They will damage F150 components.

SECTION 8

Specifications

This section provides the specifications of the F150 components.

8-1	F150 Vision Mate Controller	64
8-2	Cameras.....	66
8-3	Two-camera Unit.....	70
8-4	Console	72
8-5	Cables	72
8-6	LCD Monitor.....	74

8-1 F150 Vision Mate Controller

F150-C10E-3
F150-C15E-3

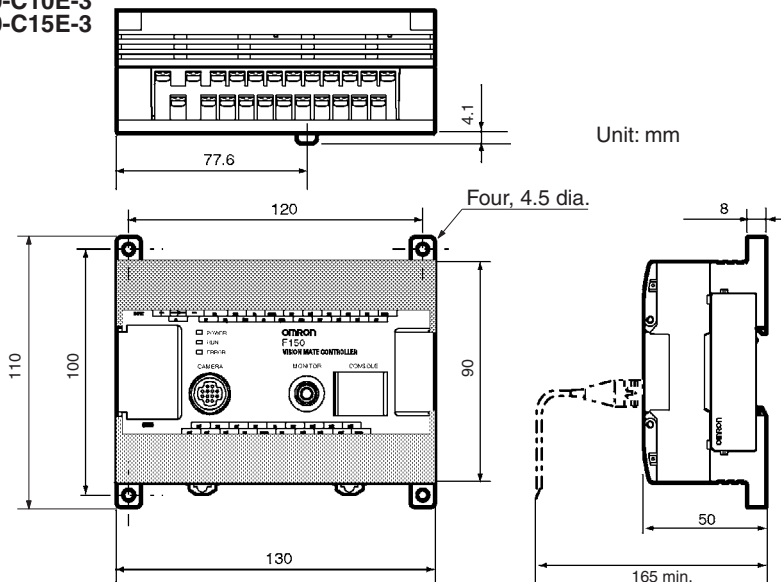

Item	Specification	
Model	F150-C10E-3	F150-C15E-3
Input/Output type	NPN	PNP
Supply voltage	20.4 to 26.4 VDC (including ripple)	
Current consumption	Approx. 0.5 A	
Insulation resistance	20 M Ω min. between all DC external terminals and GR terminal (at 100 VDC, with internal surge absorber removed)	
Dielectric strength	1,000 VAC, 50/60 Hz between all DC external terminals and GR terminal (with internal surge absorber removed)	
Leakage current	10 mA max.	
Noise resistance	1500 Vp-p; pulse width: 0.1 μ s / 1 μ s; rising time: 1 ns (pulse)	
Vibration resistance	10 to 150 Hz; half-amplitude: 0.5 mm; maximum acceleration: 70 m/s ² , 4 times for 8 minutes each in 3 directions	
Shock resistance	200 m/s ² , 3 times each in 6 directions	
Ambient temperature	Operating: 0 to 50°C; storage: -25 to +65°C (with no icing or condensation)	
Ambient humidity	Operating/storage: 35% to 85% (with no condensation)	
Ambient environment	No corrosive gases	
Protection class	Class I (with protective conductor terminal)	
Degree of protection	IEC60529 IP20 (in-panel)	
Case material	ABS/PC	
Weight	Approx. 390 g (without cable)	

F150-C10E-3-DRT

The F150-C10E-3-DRT can operate as a CompoBus/D Slave.

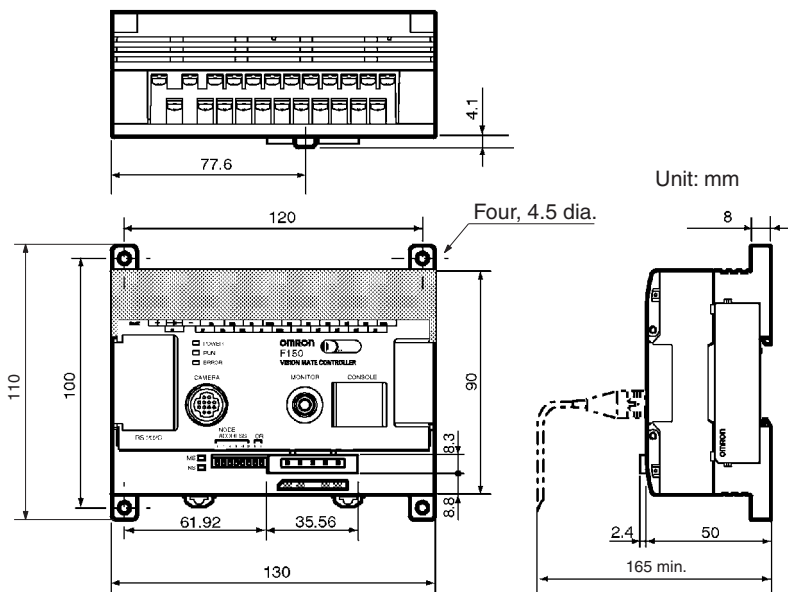

Item	Specification
Supply voltage	20.4 to 26.4 VDC (including ripple)
Current consumption	Approx. 0.5 A
Insulation resistance	20 MΩ min. between all DC external terminals and GR terminal (at 100 VDC, with internal surge absorber removed)
Dielectric strength	1,000 VAC, 50/60 Hz between all DC external terminals and GR terminal (with internal surge absorber removed)
Leakage current	10 mA max.
Noise resistance	1500 Vp-p; pulse width: 0.1μs/ 1μs; rising time: 1 ns (pulse)
Vibration resistance	10 to 150 Hz; half-amplitude: 0.5 mm; maximum acceleration: 70 m/s ² , 4 times for 8 minutes each in 3 directions
Shock resistance	200 m/s ² , 3 times each in 6 directions
Ambient temperature	Operating: 0 to 50°C; storage: -25 to +65°C (with no icing or condensation)
Ambient humidity	Operating/storage: 35% to 85% (with no condensation)
Ambient environment	No corrosive gases
Protection class	Class I (with protective conductor terminal)
Degree of protection	IEC60529 IP20 (in-panel)
Case material	ABS/PC
Weight	Approx. 390 g (without cable)

8-2 Cameras

F150-SL20A/SL50A (Camera with an F150-LT10A Light Source)

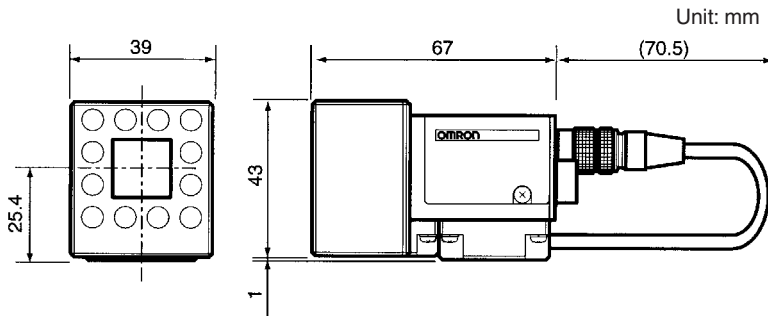

Mounting dimensions

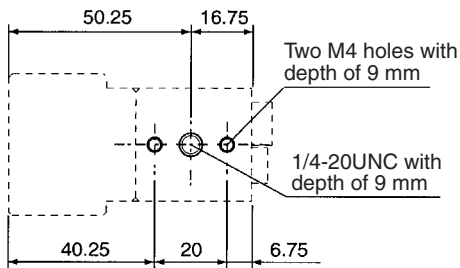

F150-SLC20 (Camera with F150-LTC20 Intelligent Light Source)

Unit: mm

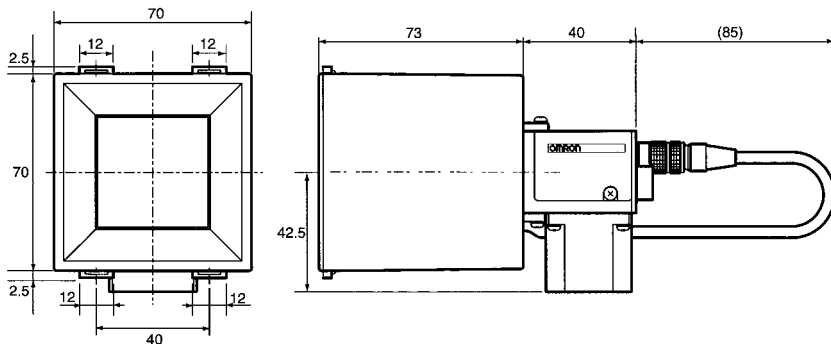

Mounting dimensions

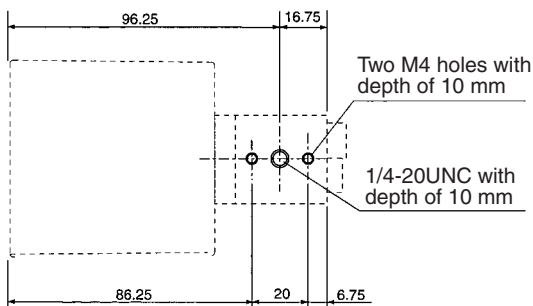

F150-SLC50 (Camera with F150-LTC50 Intelligent Light Source)

Unit: mm

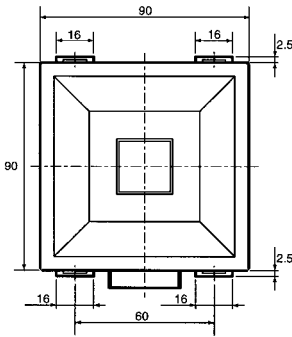

Mounting dimensions

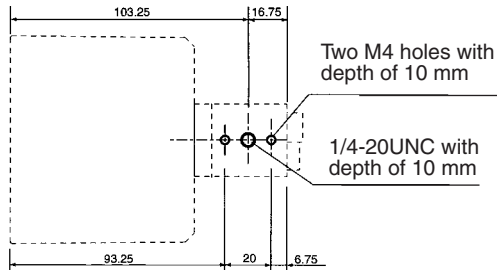
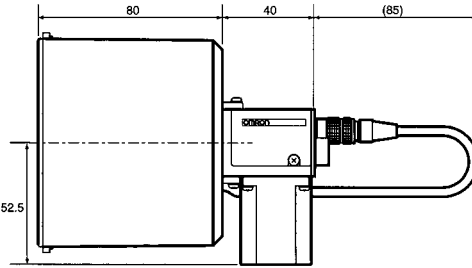

F150-S1A Camera

Unit: mm

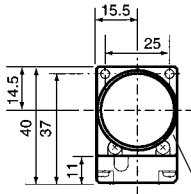

C mount

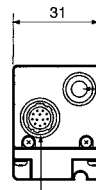
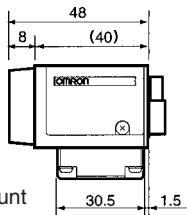

F150 light connector

F150 connector

Mounting dimensions

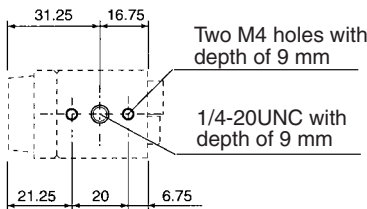

General Specifications

	F150-SL20A	F150-SL50A	F150-SLC20	F150-SLC50	F150-S1A
Supply voltage	12 VDC				
Current consumption	Approx. 110 mA		Approx. 200 mA		Approx. 100 mA
Vibration resistance	10 to 150 Hz; half-amplitude: 0.35 mm; maximum acceleration: 50 m/s ² , 10 times for 8 minutes each in 3 directions				
Shock resistance	150 m/s ² , 3 times each in 6 directions				
Ambient temperature	Operating: 0 to 50°C; storage: -25 to +65°C (with no icing or condensation)				
Ambient humidity	Operating/storage: 35% to 85% (with no condensation)				
Ambient environment	No corrosive gases				
Material of camera section	Cover: Zinc-plated steel sheet, t0.6 (SECC-C) Case: Die-cast aluminum (ADC12) Mounting base: Bakelite containing cloth (black)				
Material of light section	(F150-LT10A) Case: ABS Transparent part of light emitting side: PC		(F150-LTC20/LTC50) Case: ABS Transparent part of light emitting side: PC		---
Weight	Approx. 135 g	Approx. 135 g	Approx. 280 g	Approx. 370 g	Approx. 80 g

Performance Specifications

		F150-SL20A	F150-SL50A	F150-SLC20	F150-SLC50	F150-S1A
Camera	Picture element	1/3" Interline CCD (reading all pixels)				
	Effective pixels	659 × 494 (H × V)				
	Synchronization	External sync. via horizontal sync signal				
	Shutter speed	Electronic shutter: 1/100 s, 1/500 s, 1/2000 s, 1/10000 s				
	Lens mounting	C mount				
Lens	Model number	F150-LE20	F150-LE50	F150-LE20	F150-LE50	---
	Focussing method	Fixed focus/fixed aperture				
	Brightness	F2.8				
	Focussing distance	13 mm	6.1 mm	13 mm	6.1 mm	
Light	Light elements	Red LED		Red LED and green LED (mixed)		--- (Depends on lens)
	Lighting system	Pulse flashing (i.e., synchronized with shutter)				
Focal distance		61 to 71 mm	66 to 76 mm	15 to 25 mm	16.5 to 26.5 mm	
Field of vision		20×20 mm	50×50 mm	20×20 mm	50×50 mm	

8-3 Two-camera Unit

F150-A20

Unit: mm

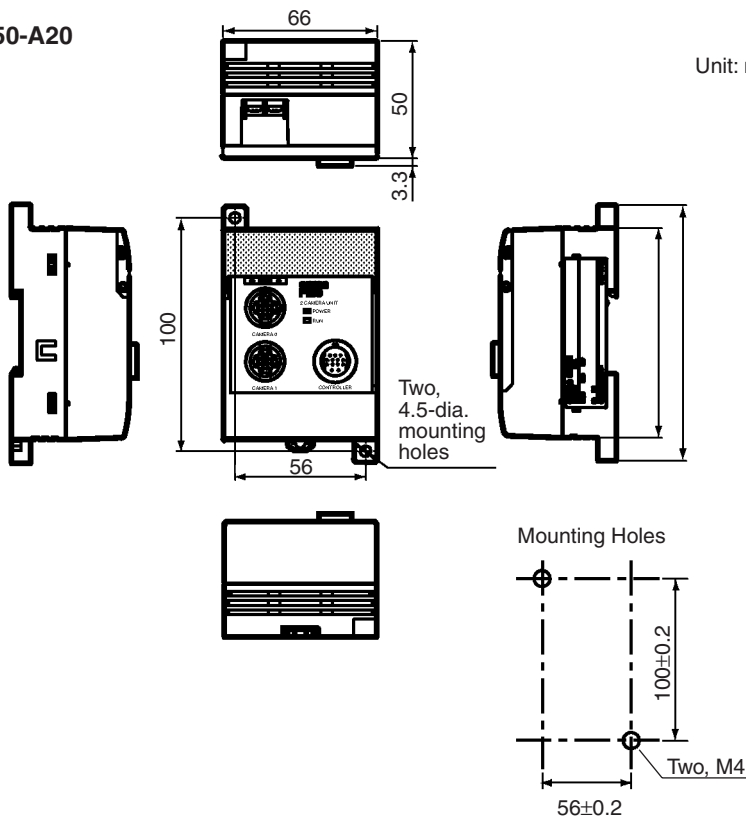

General Specifications

Item	Specification
Supply voltage	20. 4 to 26.4 (including ripple)
Current consumption	Approx. 0.3 A
Vibration resistance	10 to 150 Hz; half-amplitude: 0.35 mm; maximum acceleration: 50 m/s ² , 10 times for 8 minutes each in 3 directions
Shock resistance	150 m/s ² , 3 times each in 6 directions
Ambient temperature	Operating: 0 to 50°C; storage: -25 to +65°C (with no icing or condensation)
Ambient humidity	Operating/storage: 35% to 85% (with no condensation)
Ambient environment	No corrosive gases
Case material	ABS/PC
Weight	Approx. 220 g

Performance Specifications

Item	Specification
Number of Cameras connectable	2
Connectable Cameras	F150-S1A, F150-SL20A/SL50A/SLC20*/SLC50* (*: Light quantity can be controlled from the Controller.)
Connectable Controllers	F150-C10E-3, F150-C15E-3, F150-C10E-3-DRT
Image memory	Two sets (one for Camera 0 and the other for Camera 1)
Image reading	Simultaneous reading from two Cameras (preventing mutual light interference when using F150-SL20A/SL50A/SLC20/SLC50)
Camera modes	Two-camera switching mode Composition modes (vertical, horizontal (combining center sections, combining top/bottom sections)) One-camera modes

F150-VA Camera Unit Cable

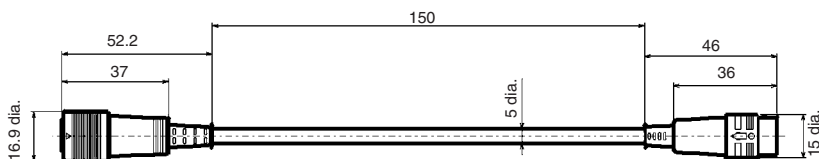

Unit: mm

Item	Specification
Vibration resistance	10 to 150 Hz; half-amplitude: 0.35 mm; maximum acceleration: 50 m/s ² , 10 times for 8 minutes each in 3 directions
Shock resistance	150 m/s ² , 3 times each in 6 directions
Ambient temperature	Operating: 0 to 50°C; storage: -25 to +65°C (with no icing or condensation)
Ambient humidity	Operating/storage: 35% to 85% (with no condensation)
Ambient environment	No corrosive gases
Material	Cable shield: Heat-resistant vinyl chloride Connector: PC containing glass, PBT
Minimum bending radius	35 mm

8-4 Console

F150-KP

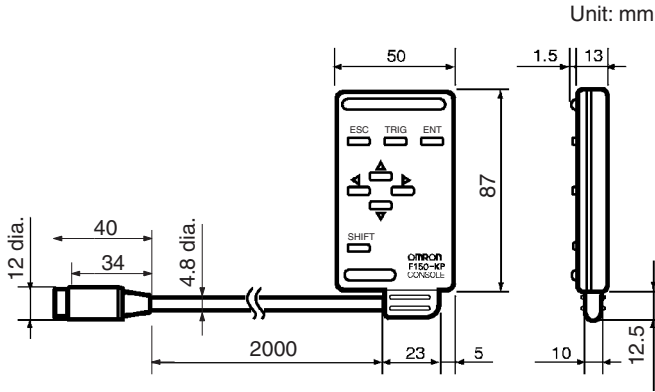

Item	Specification
Vibration resistance	10 to 150 Hz; half-amplitude: 0.15 mm, 4 times for 8 minutes each in 3 directions
Shock resistance	196 m/s ² , 3 times each in 6 directions
Ambient temperature range	Operating: 0 to 50°C; storage: -25 to +65°C (with no icing or condensation)
Ambient humidity range	Operating/storage: 35% to 85% (with no condensation)
Ambient environment	No corrosive gases
Degree of protection	IEC60529 IP20 (in-panel)
Minimum bending radius	75 mm
Material	Body: ABS Cable shield: Heat-resistant vinyl chloride Connector: PC, PBT
Weight	Approx. 135 g

8-5 Cables

F150-VS Camera Cable

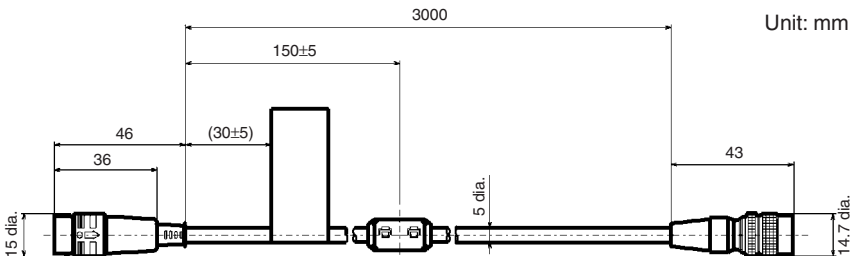

Item	Specification
Vibration resistance	10 to 150 Hz; half-amplitude: 0.15 mm, 4 times for 8 minutes each in 3 directions
Shock resistance range	196 m/s ² , 3 times each in 6 directions
Ambient temperature range	Operating: 0 to 50°C; storage: -25 to +65°C (with no icing or condensation)
Ambient humidity range	Operating/storage: 35% to 85% (with no condensation)
Ambient environment	No corrosive gases
Material	Cable shield: Heat-resistant vinyl chloride Connector: PC containing glass, PBT
Minimum bending radius	75 mm

F150-VM Monitor Cable

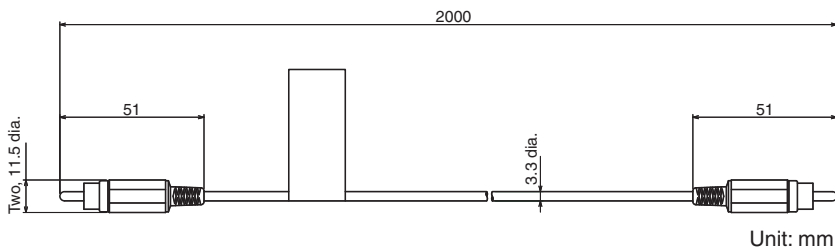

Item	Specification
Vibration resistance	10 to 150 Hz; half-amplitude: 0.15 mm, 4 times for 8 minutes each in 3 directions
Shock resistance	196 m/s ² , 3 times each in 6 directions
Ambient temperature range	Operating: 0 to 50°C; storage: -25 to +65°C (with no icing or condensation)
Ambient humidity range	Operating/storage: 35% to 85% (with no condensation)
Ambient environment	No corrosive gases
Material	Cable shield: Ultra flame-resistant vinyl chloride Connector: PVC
Minimum bending radius	50 mm

8-6 LCD Monitor

F150-M05L

Unit: mm

Mounting plate thickness: 1.6 to 4.8

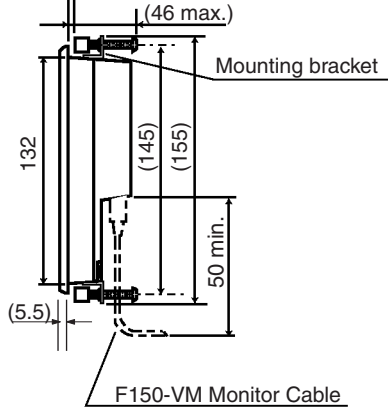
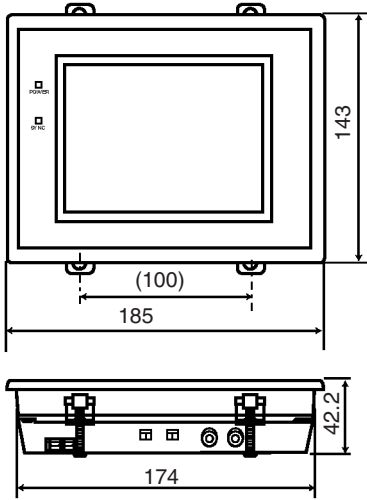

Tolerance: ± 1 mm
The dimensions in parentheses are provided for reference.

Panel opening dimensions

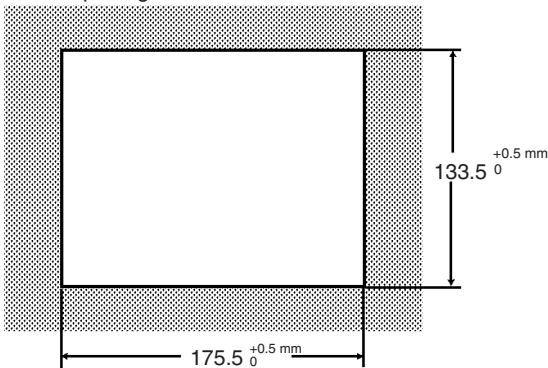

Item	Specification
Supply voltage	20.4 to 26.4 VDC (including ripple)
Current consumption	700 mA max.
Vibration resistance	10 to 150 Hz; half-amplitude: 0.1 mm, maximum acceleration: 15 m/s ² , 10 times for 8 minutes each in 3 directions
Shock resistance	150 m/s ² , 3 times each in 6 directions
Ambient temperature	Operating: 0 to 50°C; storage: -25 to +65°C (with no icing or condensation)
Ambient humidity	Operating/storage: 35% to 85% (with no condensation)
Ambient environment	No corrosive gases
Material	Case: ABS/PC Display: PMMA (acrylic)
Panel size	5.5 inches; 111.36 × 83.52 mm (H × V)
Panel type	Liquid crystal color TFT
Resolution	320 × 240 dots
Image pitch	0.348 × 0.348 mm (H × V)
Contrast	85:1 (typical)
Viewable angle	25° up/down and 50° left/right (with a contrast ratio > 10)
Luminance	250 cd/m ² (typical)
Backlight	Cold cathode fluorescent light
Response speed	60 ms max.
Input signal	NTSC composite video (1.0 V/75 Ω termination)
Weight	Approx. 1 kg

Revision History

A manual revision code appears as a suffix to the catalog number on the front cover of the manual.

Cat. No. Z141-E1-03



The following table outlines the changes made to the manual during each revision. Page numbers refer to the previous version.

Revision code	Date	Revised content
1	April 2000	Original production
1A	October 2000	Page 15: Changed the grounding class from II to I. Page 26: Changed model number F150-2A to F150-A20. Pages 48 and 49: Changed product code from 203 to 205. Page 49: Deleted F150-C15-3 from the product name. Page 72: Changed the title from K150-KP Console to Console. Address: Updated the addresses.
02	March 2002	Page 16: Made minor change to second note. Page 20: Replaced graphic. Page 30: Added sentence to second paragraph.
	October 2002	Page 30: Corrected ON current in the table.
02A	July 2003	Pages ii and iii: Added PL information.
02B	March 2005	Pages ii and iii: Revised PL information.
03	July 2006	Page ix: Manual suffixes removed. Page 13: Model number changed at top of page, BNC Jack graphic changed, and F300-M09 removed. Page 15: Model number changed at bottom of page. Page 20: Chart replaced. Page 22: Table and accompanying graphic replaced and 2-mm Extension Tube added. Page 23: Model number changed and 2-mm Extension Tube added. Page 56: Last cause cell for "the monitor is blank" changed. Pages 72 and 73: "Range" added for ambient temperature and humidity. Page 74: Page deleted.

Revision History

OMRON Corporation
Industrial Automation Company

Sensing Devices Division H.Q.
Application Sensors Division

Shiokoji Horikawa, Shimogyo-ku,
Kyoto, 600-8530 Japan
Tel: (81)75-344-7068/Fax: (81)75-344-7107

Regional Headquarters

OMRON EUROPE B.V.

Sensor Business Unit,
Carl-Benz-Str. 4, D-71154 Nufringen,
Germany
Tel: (49)7032-811-0/Fax: (49)7032-811-199

OMRON ELECTRONICS LLC

1 East Commerce Drive, Schaumburg, IL 60173
U.S.A.
Tel: (1)847-843-7900/Fax: (1)847-843-8568

OMRON ASIA PACIFIC PTE. LTD.

83 Clemenceau Avenue,
#11-01, UE Square,
239920 Singapore
Tel: (65)6835-3011/Fax: (65)6835-2711

OMRON (CHINA) CO., LTD.

Room 2211, Bank of China Tower,
200 Yin Cheng Road (M),
Shanghai, 200120 China
Tel: (86)21-5037-2222/Fax: (86)21-5037-2200

OMRON

Authorized Distributor:

Cat. No. Z141-E1-03

F150-3 Vision Sensor

Manual 1: SETUP MANUAL

OMRON